

START

DESKING SYSTEMS



Siamsteel[®]
office furniture



WELCOME TO NEW PERCEPTION

You are very welcome to enjoy and enhance your professionally working efforts with our newest workspace solutions, START, desking systems to support you throughout the day.



EFFICIENT WORKSPACE SHARING

04



Cleverly office design for non-routine office work style is always solved with benching systems; to meet the necessity in different workspace requirement, re-configuration, quick installation and relocation, this START modular systems is your best answer.

การออกแบบจัดวางที่นั่งรูปแบบใหม่ ซึ่งสามารถสลับเปลี่ยนตำแหน่งกันตามความเหมาะสมเพื่อให้สอดคล้องกับรูปแบบการทำงานของ
หน่วยงานที่ไม่จำเป็นต้องเข้าที่โต๊ะทำงานในสำนักงานเป็นประจำ ช่วยให้คุณสามารถบริหารจัดการพื้นที่ได้อย่างมีประสิทธิภาพ
 อีกทั้งมีรูปแบบให้เลือกหลากหลาย สามารถปรับแบบการจัดวางใหม่ ง่ายต่อการติดตั้ง และเคลื่อนย้ายได้อย่างรวดเร็วมากยิ่งขึ้น



CO-WORKING OR SOLOIST

06





Space planning in connecting group of units or individual workstyle, you can find an artistic choice of selections in START product range to complete the perfect layout.

สตาร์ก มีรูปแบบสีให้เลือกหลากหลาย จึงเหมาะสำหรับการใช้งานและจัดวางพื้นที่ ครบถ้วนทุกๆ รูปแบบการจัดวาง ตั้งแต่การนั่งแยกอิสระ หรือนั่งทำงานในรูปแบบกลุ่มต่างๆ

CHOICE OF CLUSTERS

08





A unique team of 3 or 4 can be connected together for easily share the information and facilities among team members; semi-transparent communication are offered together with privacy at work.

การแบ่งปันข้อมูลและอุปกรณ์เครื่องมือจะมีความสะดวกมากขึ้น ด้วยการนั่งในรูปแบบทีมซึ่งมีชุดโต๊ะสำเร็จรูปสำหรับเลือกขนาด 3 หรือ 4 ที่นั่งตามรูปแบบและจำนวนผู้นั่งที่กำหนด ซึ่งยังคงความเป็นส่วนตัวของแต่ละผู้ใช้งาน ขณะที่ช่วยย้ําการสื่อสารภายในกลุ่มมีประสิทธิภาพมากยิ่งขึ้น

AESTHETIC PROFESSIONAL OFFICE

10



Similar design concept and structure to entire office areas plus an additional glossy tempered glass worksurface options are available for selection, to reflect your vision, personality and status.

โต๊ะสำหรับผู้บริหารที่ออกแบบมาสะท้อนความเป็นผู้นำ วัสดุที่ทนและบุคลิกภาพ โดยมีความสอดคล้องทั้งรูปแบบและโครงสร้าง เช่นเดียวกับโต๊ะทำงานของหน่วยงานในสังกัด แผ่นหน้าโต๊ะสามารถเลือกเป็นกระจกนิรภัยได้



TOUCH OF NATURE

12





A wooden START managerial desk is also available in basic rectangular shape, to achieve limitation of area with minimalist concept combined with an elegance. Either small meeting or conferencing, matched worksurface finishes to managerial desk and standard desking are available.

โต๊ะสำหรับผู้บริหารที่นิยมในความเรียบง่าย แต่ยังคงความงดงามมีระดับและให้ความรู้สึกที่สืบทอดธรรมชาติ ซึ่งได้รับการออกแบบ ให้มีความครอบคลุมทั้งในส่วนองโต๊ะประชุมขนาดเล็ก ที่ใช้ร่วมภายในห้องทำงานเดียวกัน รวมถึงโต๊ะขนาดใหญ่สำหรับจัดวางในห้องประชุมโดยเฉพาะ

KNOWLEDGE MANAGEMENT

14





The concept of lifetime learning becomes more essential than ever, need of regularly training programs for interchange, coaching and modernizing the information are required. For better accommodation of these courses, a suitable START product range is pre-selected.

โต๊ะ-อนรมที่ได้รับการออกแบบให้เหมาะต่อการใช้งาน ทั้งในส่วนของขนาดที่เหมาะสมและตอบสนองต่อการใช้งานเป็นพิเศษ
ให้เหมาะสมที่สุด ต่อการอนรมเพื่อเพิ่มศักยภาพของบุคลากรขององค์กร

CORDIALLY RECEPTION

16



Extensive range for welcome area, a reception configuration are pioneered in conceive of necessity and harmonious form throughout the office space.

การออกแบบผลิตภัณท์ในส่วนของผู้ต้อนรับ มีแนวคิดริเริ่มจากความจำเป็นในการใช้งานภายในสำนักงาน โดยยังคงรูปแบบที่สอดคล้องกับพื้นที่ส่วนอื่นๆ ได้อย่างลงตัว

Cable management

18

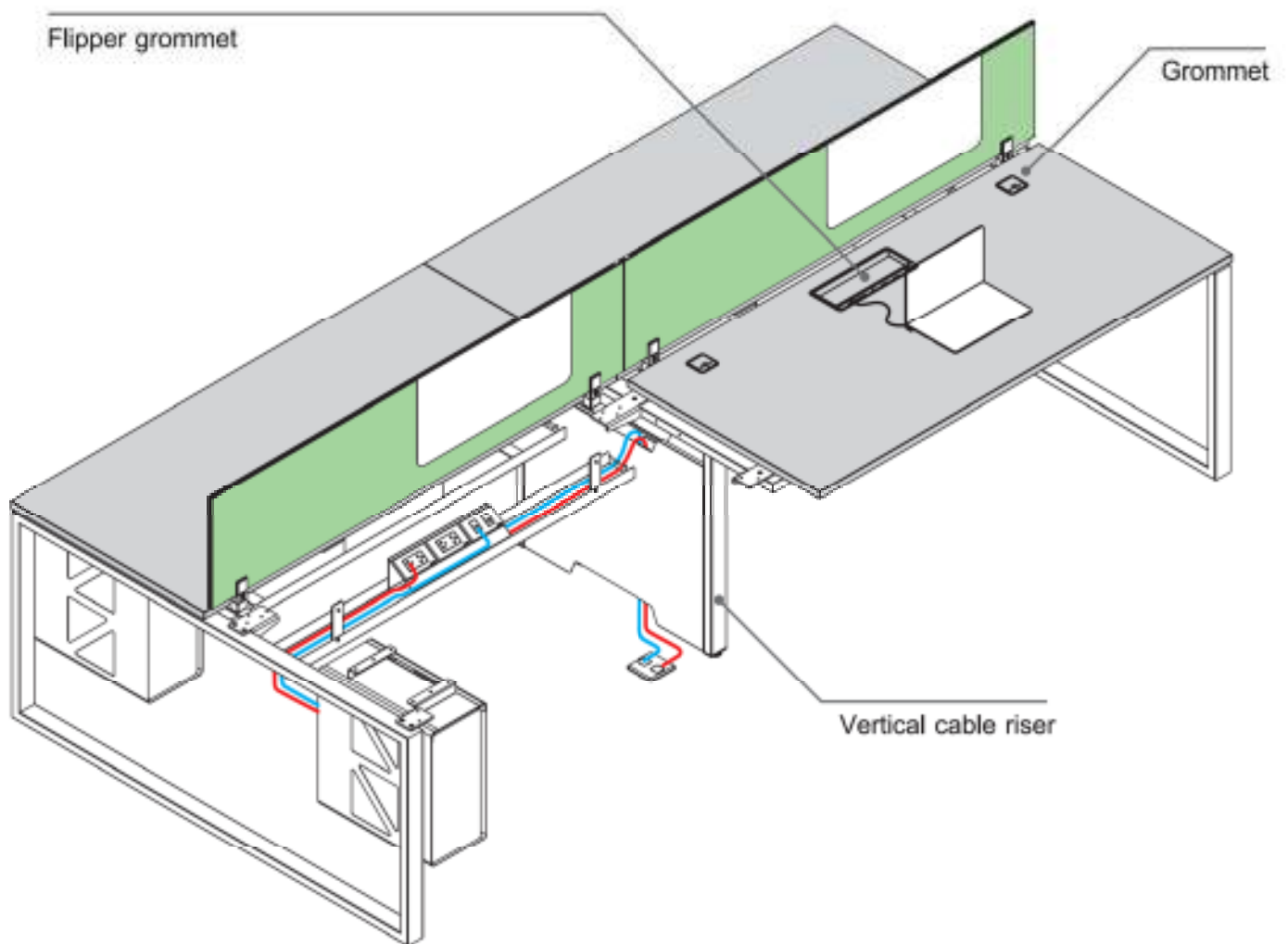

Features



A-leg



Grommet



B-leg

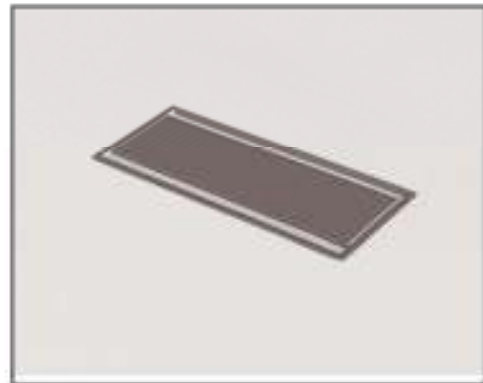

Double-sided top access



Front fabric screen



Flipper grommet



Side screen



Vertical cable riser

Design Principles

" The prime objective in designing of START is to create a desking system which not only to fulfill all basic usage requirements but to offer an aesthetical outstanding design plus functions in serving your truly lifestyle with comforts.

All products must incorporating more environmentally sustainable materials and manufacturing processes, also compliance to safety and performances according to international standards.

Sustainability materials can be applied per requested.

All dedicated time in research to understand user' manners and worklife activities, years of experience in development of R&D combined with an in-depth technical know-hows on all stages from design to production, we certainly that START will be one of your inspiration to have a great working day. "

20

Siamsteel R&D Team

PRAGMATIC WAY OF COLLECTION



21

DESKS

- Single • Double desks
- Single • Double bench desks
- Single • Double connector desks
- 90 • 120-Degree cluster desks
- Single • Double Return Desks
- Training desks

22

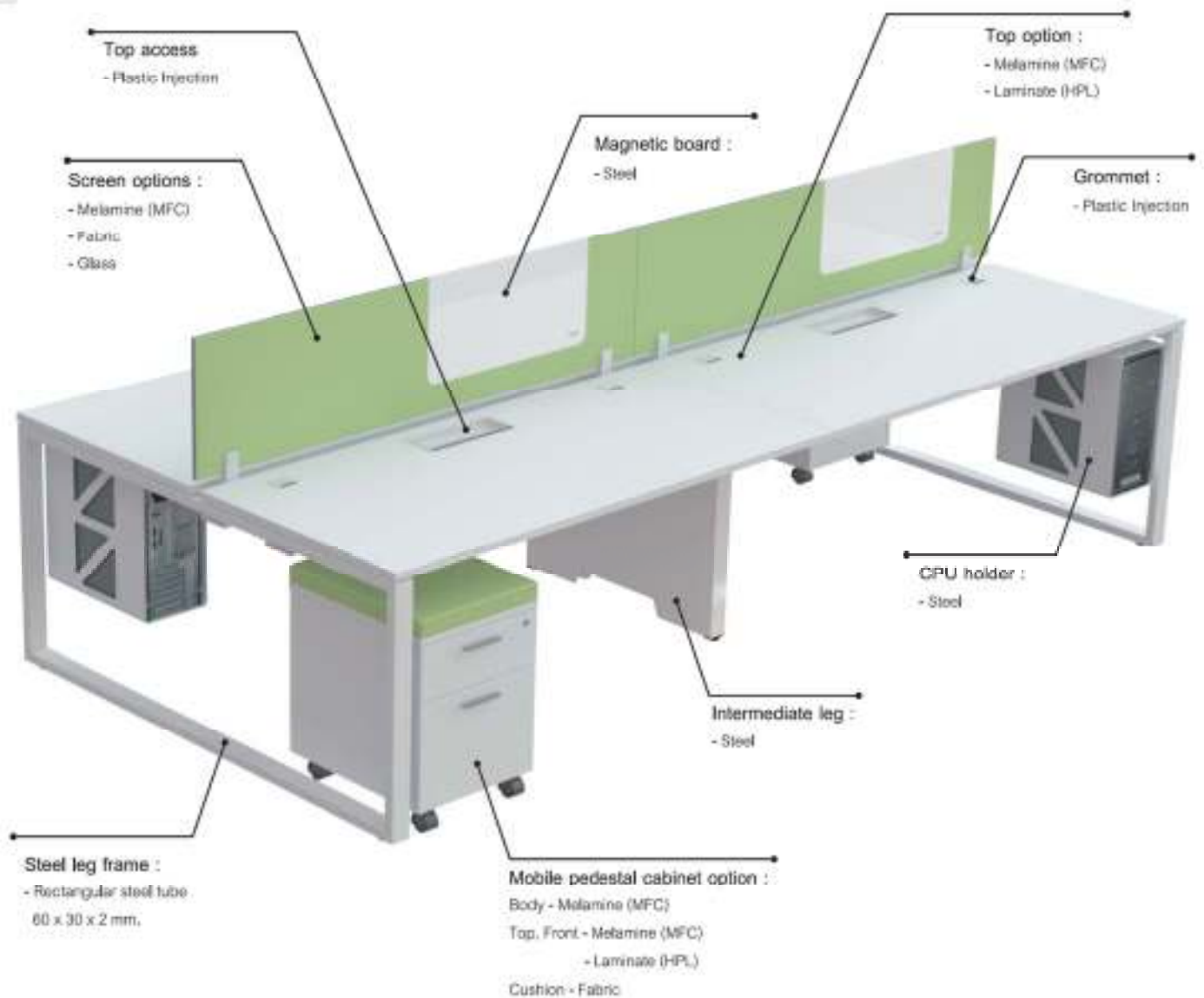

EXECUTIVE DESK

- Executive desk with top access
- Glass top executive desk
- Glass top return desk
- Executive support cabinet
- Glass top executive desk with support cabinet

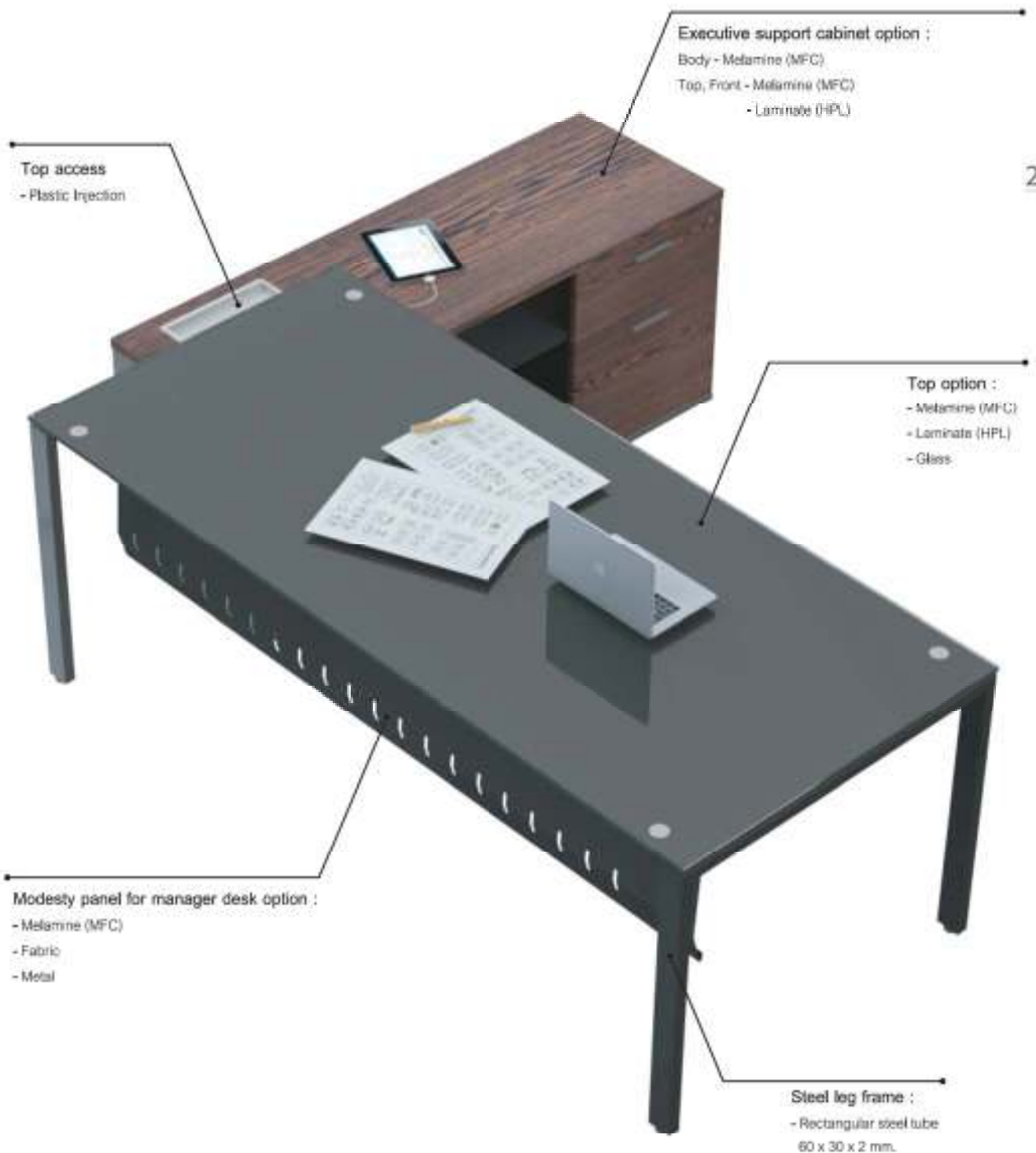

MEETING - CONFERENCE TABLES

- Wooden top square meeting table
- Glass top square meeting table
- Wooden top rectangle meeting table
- Glass top rectangle meeting table
- Wooden top conference table
- Glass top conference table
- Wooden top conference connector table
- Glass top conference connector table

24

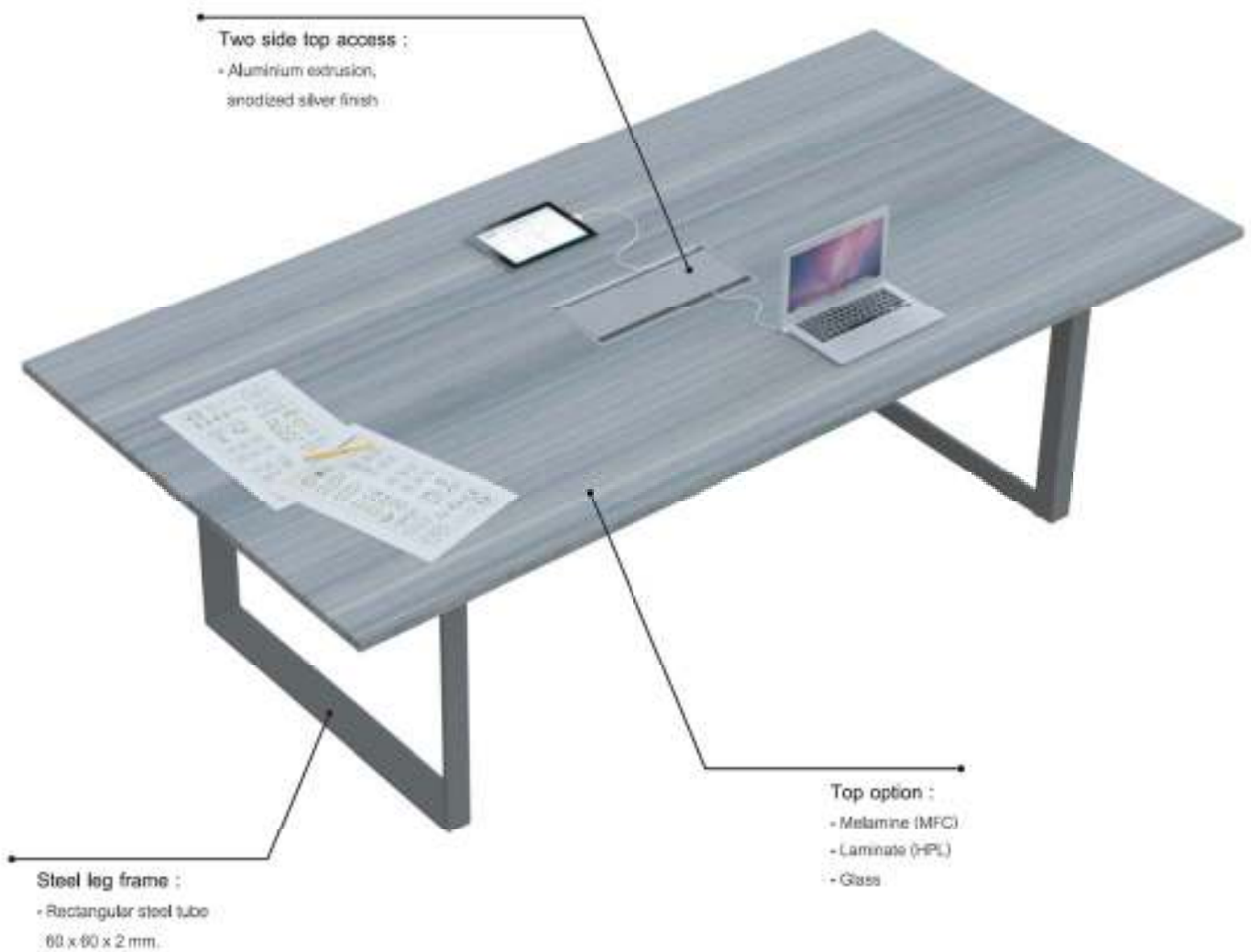

CABINET

- 2-, 3-drawer support pedestal
- Open shelf with 2-drawer support cabinet
- CPU with sliding door support cabinet
- Return desks with support pedestal
- Support cabinet for executive desk
- Desk height pedestal
- Desk height pedestal with bookshelf
- Sliding door cabinet
- Sliding door cabinet with bookshelf
- Mobile pedestal
- Open shelf with 2-drawer mobile cabinet

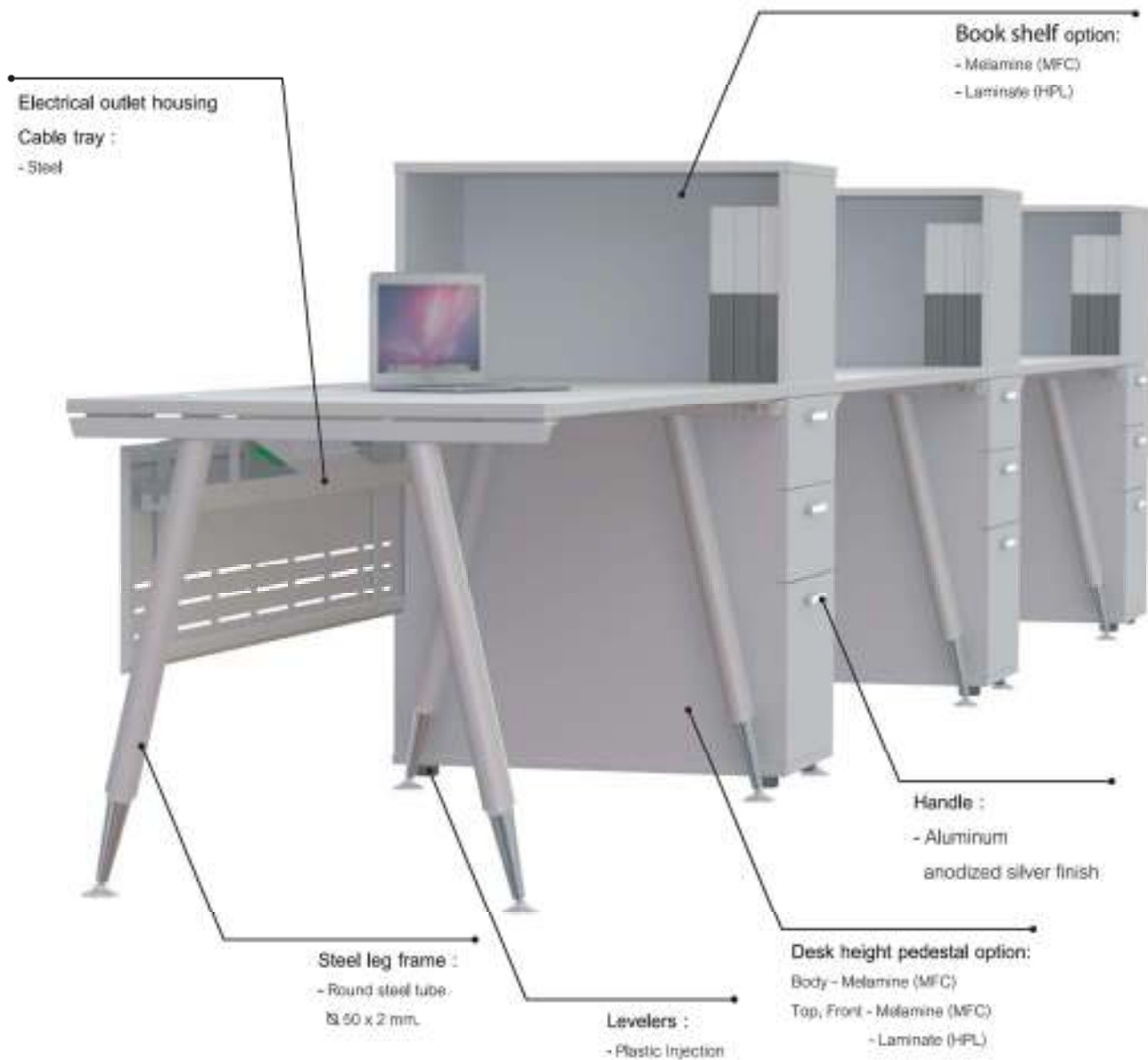

RECEPTION COUNTER

- Single reception counter
- Straight reception counter
- Corner reception counter
- Connector reception counter
- Straight reception counters with support cabinets

26

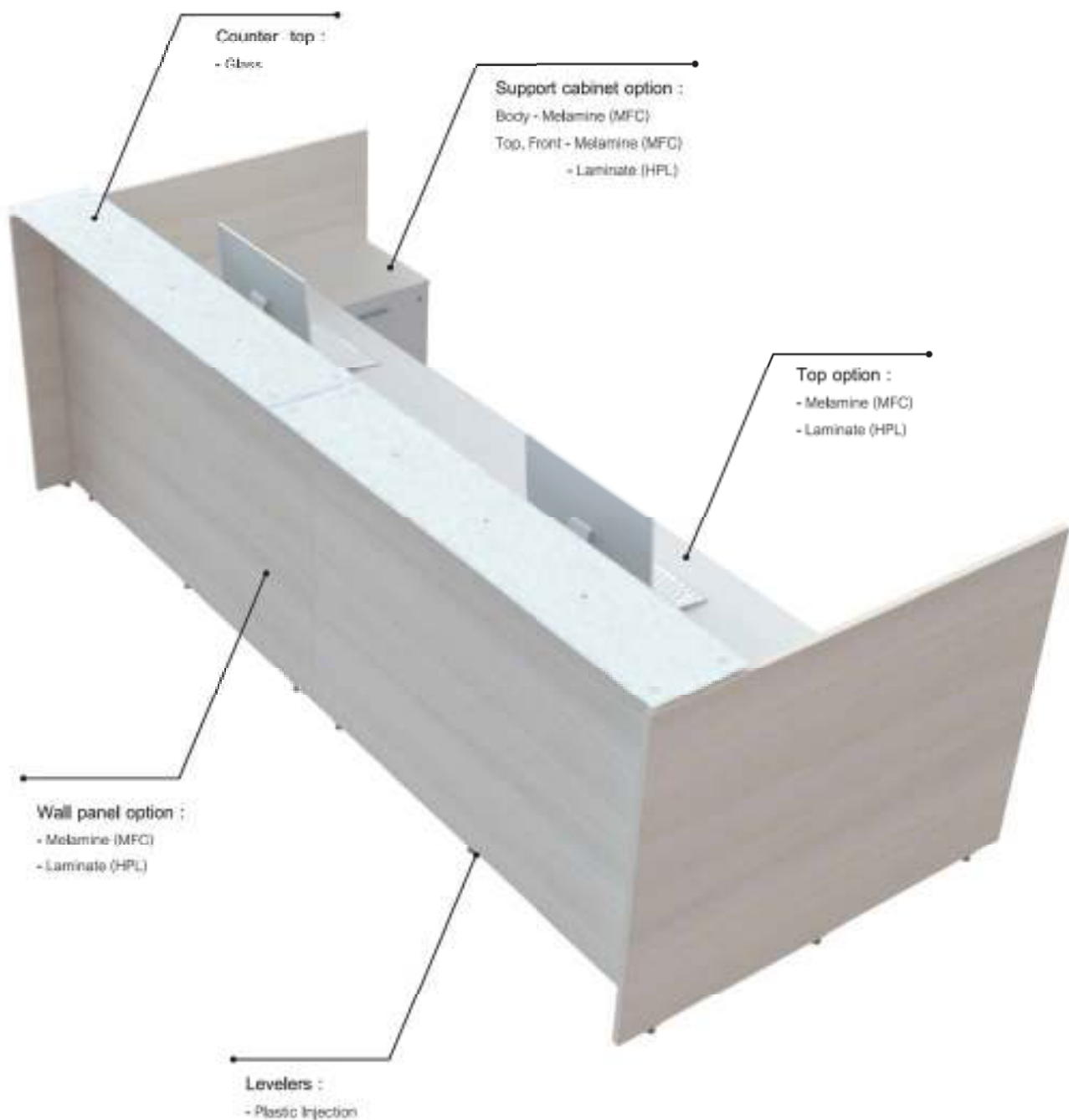

■ คุณสมบัติของท็อปโต๊ะ (Desk top)

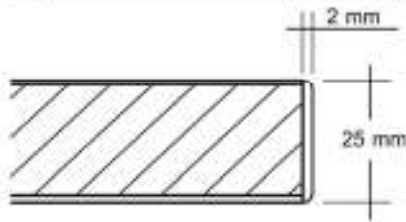

วัสดุ : ฝ้าฝ้าทึบเอบอร์ด ทหนา 25 มม.
การปิดผิว : เมลามีน (MFC) และไฮเพรสเชอร์ลามิเนต (HPL)
ปิดขอบ : แถบพลาสติก (ABS) ทหนา 2 มม.

เมลามีน (MFC) :

ฝ้าฝ้าทึบเอบอร์ดทหนา 25 มม. ปิดผิวด้วยเมลามีนและปิดขอบด้วยแถบพลาสติก ทหนา 2 มม. รอบด้าน เพื่อป้องกันการกระแทก

ไฮเพรสเชอร์ลามิเนต (HPL) :

ฝ้าฝ้าทึบเอบอร์ดทหนา 25 มม. ปิดผิวด้วยไฮเพรสเชอร์ลามิเนตและปิดขอบด้วยแถบพลาสติกทหนา 2 มม. รอบด้านเพื่อป้องกันการกระแทก



วัสดุ : กระจกนิรภัยเทมเปอร์ (Tempered glass) ทหนา 12 มม.

กระจกนิรภัยเทมเปอร์ (Tempered glass)

กระจกเทมเปอร์ทหนา 12 มม. มีคุณสมบัติสามารถทนต่อแรงกระแทบได้มากกว่ากระจกธรรมดา ที่มีความหนาเดียวกัน 3-5 เท่า ตัววัสดุสามารถนำกลับไม่ใช้ใหม่ (recycle) ได้ 100% กระจกเทมเปอร์เคลือบสี (Color Coated Glass) หนึ่งด้าน เพื่อให้ได้กระจกสีที่ต้องการ

■ โครงสร้างขา (Leg frame)

ขาเอ (Leg A) :

เหล็กกล่องหน้าตัดขนาด 60x30 มม. ทหนา 2 มม. คัดเชื่อมเข้ามุม 45 องศา และทำการพ่นสี Epoxy powder coating หนาที่สุดทหนา 180-200 องศาเซลเซียส
 ขาปรับระดับขนาดเส้นผ่านศูนย์กลาง 38 มม. เป็นพลาสติก ABS ฉีดขึ้นรูป ช่วยในการปรับขาโต๊ะ ให้มีความสมดุลกันในกรณีทีพื้นไม่เรียบอยู่ในระดับเดียวกันสามารถปรับได้ไม่เกิน 20 มม.



โครงขา : A



จุดขาปรับระดับ

ขาบี (Leg B) :

เหล็กกล่องหน้าตัดขนาด 60x30 มม. ทหนา 2 มม. คัดเชื่อมเข้ามุม 45 องศา และทำการพ่นสี Epoxy powder coating หนาที่สุดทหนา 180-200 องศาเซลเซียส
 ขาปรับระดับขนาดเส้นผ่านศูนย์กลาง 38 มม. เป็นพลาสติก ABS ฉีดขึ้นรูป ช่วยในการปรับขาโต๊ะ ให้มีความสมดุลกันในกรณีทีพื้นไม่เรียบอยู่ในระดับเดียวกันสามารถปรับได้ไม่เกิน 20 มม.

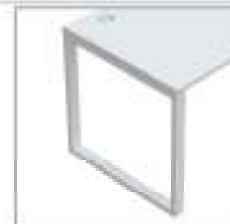

โครงขา : B

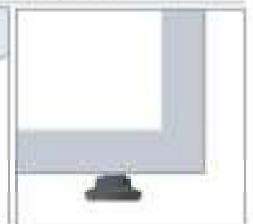

จุดขาปรับระดับ

ขาซี (Leg C) :

ขาชุดบนประกอบด้วยเหล็กกล่องหน้าตัดขนาด 60x30 มม. ทหนา 2 มม. และเหล็กท่อกลมเส้นผ่านศูนย์กลางขนาด 50 มม. ทหนา 2 มม. ทำการพ่นสี Epoxy powder coating หนาที่สุดทหนา 180-200 องศาเซลเซียส ขาชุดล่างเหล็กท่อกลมเส้นผ่านศูนย์กลางขนาด 38 มม. ทหนา 2 มม. ผ่านขั้นตอนการ ทุบปลายและชุบโครเมียม ปลอดภัยกับขาชุดล่างและฐานขาปรับระดับได้เป็นพลาสติกฉีดขึ้นรูป ขาสามารถปรับระดับได้ไม่เกิน 15 มม.



โครงขา : C



จุดขาปรับระดับ

ขาดี (Leg D) :

ท่อเหล็กรีดขึ้นรูปหน้าตัดขนาด 60x60 มม. ทหนา 2 มม. คัดเชื่อมเข้ามุม 45 องศา และทำการพ่นสี Epoxy powder coating หนาที่สุดทหนา 180-200 องศาเซลเซียส
 ขาปรับระดับขนาดเส้นผ่านศูนย์กลาง 38 มม. เป็นพลาสติก ABS ฉีดขึ้นรูป ช่วยในการปรับขาโต๊ะ ให้มีความสมดุลกันในกรณีทีพื้นไม่เรียบอยู่ในระดับเดียวกันสามารถปรับได้ไม่เกิน 20 มม.



โครงขา : D



จุดขาปรับระดับ

■ คาน (Beam)

เหล็กกล่องหน้าตัดขนาด 60x30 มม. ทนหนา 2 มม. เชื่อมพลาสมา 3 มม. ที่ปลายทั้งสองด้านของคาน สำหรับประกอบยึดกับขา ฟันสี Epoxy powder coating หนาที่อุณหภูมิ 180-200 องศาเซลเซียส



โครงสร้างขาและคาน (Desk structure)

หน้าตัดของเหล็กกล่อง

■ อุปกรณ์จากยึดที่ท็อปโต๊ะและติดตั้งจากกัน (Top support bracket)

อุปกรณ์จากยึดที่ท็อปโต๊ะและติดตั้งจากกัน อุปกรณ์จากยึดจะถูกติดตั้งเข้ากับขาโต๊ะ ผลิตด้วยการกระบวนการฉีดขมูมิเนื้อโมเดสตีง ฟันสี Epoxy powder coating หนาที่อุณหภูมิ 180-200 องศาเซลเซียส

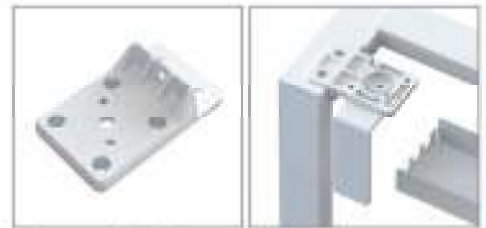

Top support bracket

■ การจัดการระบบไฟฟ้าและการเข้าถึงข้อมูล (Cable management)

โต๊ะ START ผู้ใช้งานสามารถเข้าถึงระบบไฟฟ้าและระบบ LAN จากบนที่ท็อปโต๊ะของผู้ใช้งานได้ 2 ช่องทางคือ

1. ช่องเสียบปลั๊กไฟจากบนที่ท็อปโต๊ะ (Plastic top access) : ช่วยให้ผู้ใช้สามารถเสียบปลั๊กไฟจากด้านบนของท็อปโต๊ะได้อย่างสะดวกด้วยช่องขนาด 120 X 300 มม. ผลิตด้วยพลาสติก ABS ฉีดขึ้นรูป
2. ช่องร้อยสายไฟ (Grommet) : ช่วยในการจัดการร้อยสายไฟบนที่ท็อปโต๊ะลงสู่รางร้อยสายไฟได้อย่างเป็นระเบียบเหมาะกับการร้อยสายไฟที่ไม่จำเป็นต้องเข้าออกบ่อย ติดตั้งทางซ้ายและขวาของท็อปโต๊ะ ผลิตด้วยพลาสติก ABS ฉีดขึ้นรูป



Plastic top access

Grommet

รางร้อยสายไฟและกล่องติดตั้งปลั๊กไฟ (Cable tray & electrical outlet housing) :

ภายในที่ท็อปโต๊ะยังมีระบบกระจายสายไฟด้วย รางร้อยสายไฟและกล่องติดตั้งปลั๊กไฟ ช่วยในการกระจายสายไฟไปยังโต๊ะต่างๆ ภายในได้อย่างเป็นระเบียบ รางร้อยสายไฟผลิตจากเหล็กแผ่นหนา 1 มม. พับขึ้นรูป และกล่องติดตั้งปลั๊กไฟใช้เหล็กแผ่นหนา 1.2 มม. และทำการฟันสี Epoxy powder coating หนาที่อุณหภูมิ 180-200 องศาเซลเซียส



Cable tray & electrical outlet housing

- รางร้อยสายไฟจะถูกติดตั้งเข้ากับคานโครงสร้างของโต๊ะ

■ แผ่นบังตา (MODESTY PANEL)

แผ่นบังตาไม้ (Wooden panel) :

ไม้ปาติเกิลบอร์ดหนา 16 มม. บิดมิดด้วยเมลามีนหรือโอเพนเซลเซอร์กานิคและปิดขอบด้วยแถบพลาสติก (ABS) หนา 1 มม. รอบด้านเพื่อป้องกันการกระแทก ประกอบกับเหล็กฉากสำหรับยึดหนา 6 มม. ติดตั้งเข้ากับโครงสร้างใต้ที่ท็อปโต๊ะ

แผ่นบังตาหุ้มผ้า (Fabric panel) :

ไม้ปาติเกิลบอร์ดหนา 16 มม. หุ้มด้วยผ้า ประกอบกับเหล็กฉากสำหรับยึดหนา 6 มม. ติดตั้งเข้ากับโครงสร้างใต้ที่ท็อปโต๊ะ

แผ่นบังตาเหล็ก (Metal panel) :

เหล็กแผ่นหนา 0.7 มม. เจาะตลอดสายและพับขึ้นรูปประกอบกับเหล็กฉากสำหรับยึดหนา 6 มม. ฟันสี Epoxy powder coating หนาที่อุณหภูมิ 180-200 องศาเซลเซียส ติดตั้งเข้ากับโครงสร้างใต้ที่ท็อปโต๊ะ



Wooden panel



Fabric panel



Metal panel

■ จากัน (Screen panel)

■ จากันไม้ (Wooden screen) :

ไม้ปาติเกิลบอร์ดหนา 16 มม. ปิดผิวด้วยเมลามีนหรือไฮเพอร์เซอร่ามีเนตและปิดขอบด้วยแถบพลาสติก (ABS) หนา 1 มม. เสารองรับไม้และฝังอลูมิเนียมรอบด้าน



■ จากันหุ้มผ้า (Fabric screen) :

ไม้ปาติเกิลบอร์ดหนา 16 มม. หุ้มด้วยผ้า เสารองรับไม้และฝังอลูมิเนียมรอบด้าน



■ จากันกระจก (Glass screen) :

■ กระจกนิรภัยเทมเปอร์ (Tempered glass)

กระจกเทมเปอร์หนา 6 มม. มีคุณสมบัติสามารถทนต่อแรงกระแทกได้มากกว่ากระจกธรรมดา ที่มีความหนาเดียวกัน 3-5 เท่า ทนทานต่อสภาวะการเปลี่ยนแปลงอุณหภูมิแบบฉับพลัน การแตกของกระจกเทมเปอร์ จะแตกกระจายออกเป็นเม็ดเล็กๆ คล้ายเม็ดข้าวโพด และมีความคมน้อยซึ่งลดอันตรายที่เกิดจากกระจกบาดตัววัสดุสามารถนำกลับไปรีไซเคิลได้ 100% สามารถเลือกเป็นกระจกใสหรือกระจกฝ้า (พ่นทรายสองด้าน)



■ อุปกรณ์จับยึดจากรัน

■ ตัวจับยึดจากรัน (Clamp for front screen) :

ตัวจับยึดจากรัน ผลิตด้วยกระบวนการจืดอลูมิเนียมโคเคลตติ้ง ฟันสี Epoxy powder coating หนาที่อุณหภูมิ 180-200 องศาเซลเซียส ติดตั้งพร้อมกับเหล็กแผ่นหนา 6 มม. สำหรับติดตั้งเข้ากับโครงสร้างใต้ที่ขอบโต๊ะ



Clamp for front screen Bracket for screen plus modesty

■ เหล็กจากรันยึดจากรัน (Bracket for screen plus modesty) :

เหล็กจากรันยึดสำหรับติดตั้งจากรันเข้ากับโครงสร้างใต้ที่ขอบโต๊ะ ผลิตจากเหล็กแผ่นหนา 6 มม. ผ่านขั้นตอนการตัด เจาะและพับขึ้นรูป ฟันสี Epoxy powder coating หนาที่อุณหภูมิ 180-200 องศาเซลเซียส

■ ตู้ข้างโต๊ะ (Desk side cabinet)

1. ท็อปตู้ (Top) : ไม้ปาติเกิลบอร์ดหนา 25 มม. ปิดผิวด้วยเมลามีนหรือไฮเพอร์เซอร่ามีเนตและปิดขอบด้วยแถบพลาสติก ABS หนา 2 มม. รอบด้าน
2. ชั้นวาง (Shelve) : ไม้ปาติเกิลบอร์ดหนา 19 มม. ปิดผิวด้วยเมลามีนและปิดขอบด้วยแถบพลาสติก ABS หนา 2 มม. รอบด้าน
3. ตัวตู้ (Body) : ไม้ปาติเกิลบอร์ดหนา 19 มม. ปิดผิวด้วยเมลามีนและปิดขอบด้วยแถบพลาสติก ABS หนา 2 มม.
4. หน้าบานตู้ (Front) : ไม้ปาติเกิลบอร์ดหนา 19 มม. ปิดผิวด้วยเมลามีนหรือไฮเพอร์เซอร่ามีเนตและปิดขอบด้วยแถบพลาสติก ABS หนา 2 มม. รอบด้าน
5. มือจับ (Handle) : อลูมิเนียมโคเคลตติ้งขึ้นรูป ทำสีอีพอกซีสีเงิน
6. รางลื่นชั๊กลูกปืน (Ball bearing slides) : รับน้ำหนักได้ไม่เกิน 20 กก. ผลิตจากเหล็กชุบโครมาไนต์
7. รางเลื่อนหน้าบาน (Sliding track) : อลูมิเนียมเหล็กพวยขึ้นรูป ทำสีอีพอกซีสีเงิน
8. ขาปรับระดับ (Levelers) : เป็นพลาสติก ABS ขึ้นรูป



■ SINGLE DESK

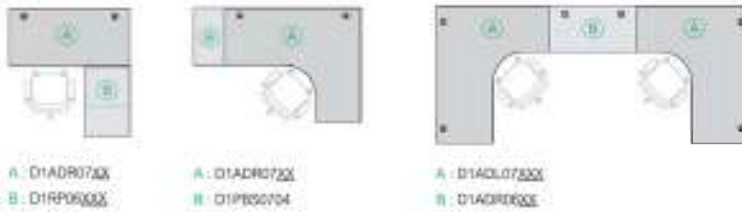

■ SINGLE BENCH DESKS

30

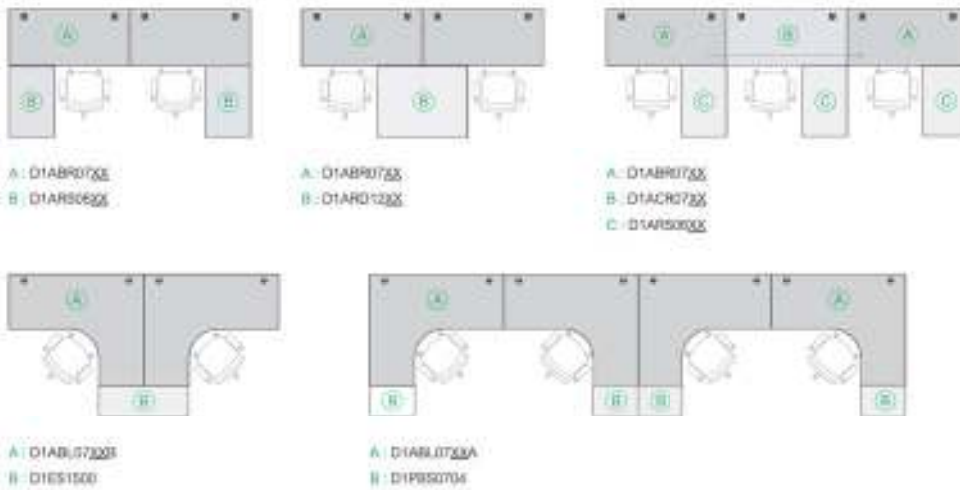

■ DOUBLE DESKS

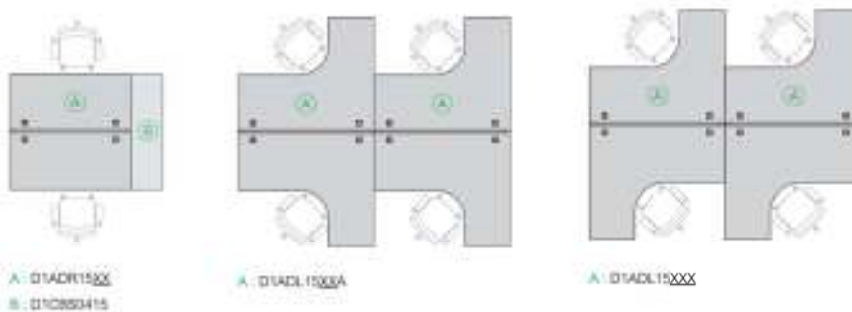

■ DOUBLE BENCH DESKS

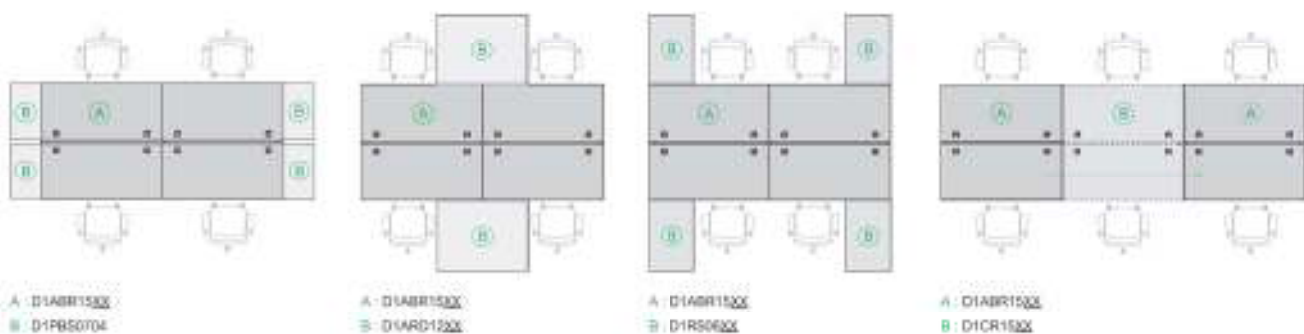

■ 90, 120-DEGREE CLUSTER DESKS

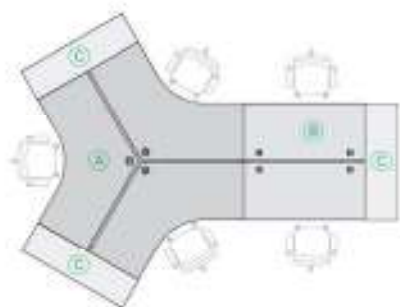

A : D1ACT200S
 B : D1ADR150S
 C : D1ES1000

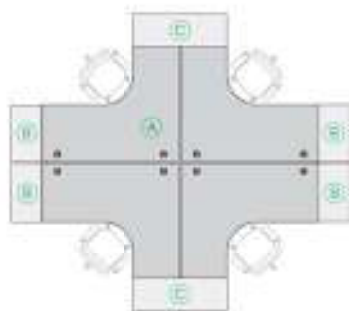

A : D1ACF300S
 B : D1PSS0704
 C : D1ES1000

■ EXECUTIVE GROUP



A : D1AEDA000S
 B : D1AAS000S



A : D1AEDGP0800S
 B : D1PSP0015

■ MEETING TABLE



A : D1AMSG1200



A : D1AMRA1224

■ CONFERENCE TABLE

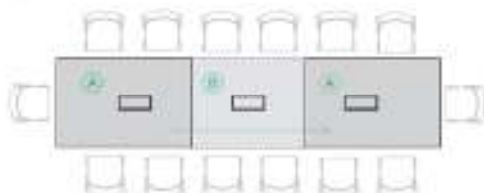

A : D1ACTA1236
 B : D1GTA1216

■ TRAINING TABLE

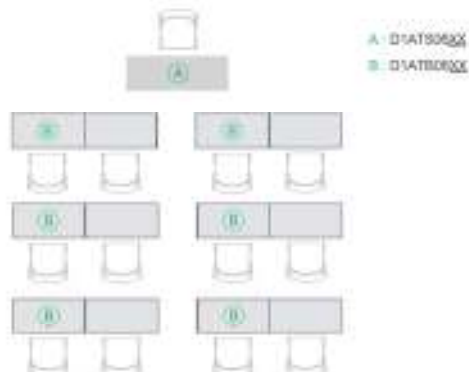

A : D1AT000S
 B : D1AT000S

■ RECEPTION COUNTERS

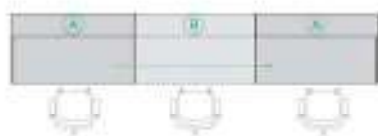

A : D1R00002
 B : D1RC0016

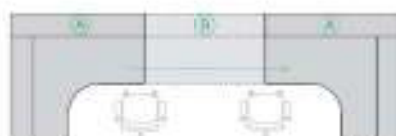

A : D1RC1600
 B : D1RC0016

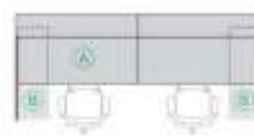

A : D1RSP1432
 B : D1RSC1104S

MODEL CODING

Rectangle top access single desk with support cabinet

MODEL : D1ADRAP0716R

SERIES NUMBER - DESK ITEM - SUPPORT PEDESTAL - WIDTH

D1 | A | DRAP | 07 | 16 | R

LEG - TOP ACCESS - DEPTH - TYPE, L R

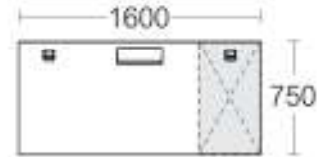

32

" Right Handed Shown "
(Installation support pedestal on right hand)

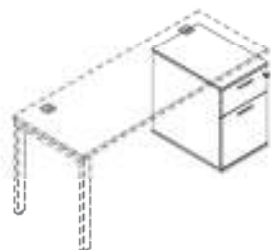
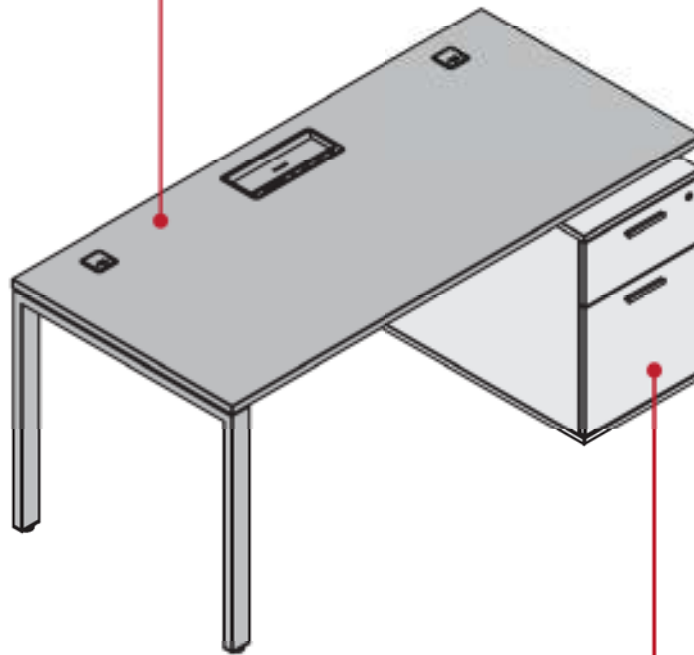

2-drawer support pedestal

MODEL : D1PSA0704

SERIES NUMBER - PEDESTAL ITEM - DEPTH - WIDTH

D1 | PSA | 07 | 04

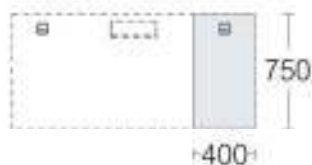

DESKS

SINGLE DESK

Rectangle single desk



D1ADR0612	1200W	600D	750H
D1ADR0614	1400W	600D	750H
D1ADR0615	1500W	600D	750H
D1ADR0616	1600W	600D	750H
D1ADR0618	1800W	600D	750H

D1ADR0712	1200W	750D	750H
D1ADR0714	1400W	750D	750H
D1ADR0715	1500W	750D	750H
D1ADR0716	1600W	750D	750H
D1ADR0718	1800W	750D	750H

Rectangle single desk with top access



D1ADRA0612	1200W	600D	750H
D1ADRA0614	1400W	600D	750H
D1ADRA0615	1500W	600D	750H
D1ADRA0616	1600W	600D	750H
D1ADRA0618	1800W	600D	750H

D1ADRA0712	1200W	750D	750H
D1ADRA0714	1400W	750D	750H
D1ADRA0715	1500W	750D	750H
D1ADRA0716	1600W	750D	750H
D1ADRA0718	1800W	750D	750H

L-shaped single desk

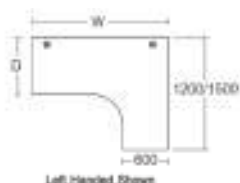

D1ADL0615L	1500W	600D	750H
D1ADL0616L	1600W	600D	750H
D1ADL0618L	1800W	600D	750H

D1ADL0615R	1500W	600D	750H
D1ADL0616R	1600W	600D	750H
D1ADL0618R	1800W	600D	750H

D1ADL0716L	1600W	750D	750H
D1ADL0718L	1800W	750D	750H

D1ADL0716R	1600W	750D	750H
D1ADL0718R	1800W	750D	750H

L-shaped single desk with top access



D1ADLA0615L	1500W	600D	750H
D1ADLA0616L	1600W	600D	750H
D1ADLA0618L	1800W	600D	750H

D1ADLA0615R	1500W	600D	750H
D1ADLA0616R	1600W	600D	750H
D1ADLA0618R	1800W	600D	750H

D1ADLA0716L	1600W	750D	750H
D1ADLA0718L	1800W	750D	750H

D1ADLA0716R	1600W	750D	750H
D1ADLA0718R	1800W	750D	750H

End desk



D1ADE0612	1240W	600D	750H
D1ADE0715	1540W	750D	750H

End desk with top access

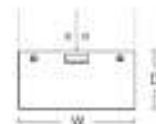

D1ADEA0612	1240W	600D	750H
D1ADEA0715	1540W	750D	750H

SINGLE BENCH DESKS

Rectangle single bench desks

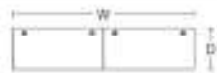

D1ABR0624	2400W	600D	750H
D1ABR0628	2800W	600D	750H
D1ABR0630	3000W	600D	750H
D1ABR0632	3200W	600D	750H
D1ABR0636	3600W	600D	750H

D1ABR0724	2400W	750D	750H
D1ABR0728	2800W	750D	750H
D1ABR0730	3000W	750D	750H
D1ABR0732	3200W	750D	750H
D1ABR0736	3600W	750D	750H

Rectangle single bench desks with top access



D1ABRA0624	2400W	600D	750H
D1ABRA0628	2800W	600D	750H
D1ABRA0630	3000W	600D	750H
D1ABRA0632	3200W	600D	750H
D1ABRA0636	3600W	600D	750H

D1ABRA0724	2400W	750D	750H
D1ABRA0728	2800W	750D	750H
D1ABRA0730	3000W	750D	750H
D1ABRA0732	3200W	750D	750H
D1ABRA0736	3600W	750D	750H

L-shaped single bench desks Type : A

34

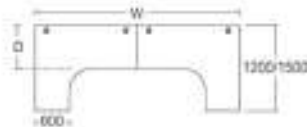

D1ABL0630A	3000W	600D	750H
D1ABL0632A	3200W	600D	750H
D1ABL0636A	3600W	600D	750H

D1ABL0732A	3200W	750D	750H
D1ABL0736A	3600W	750D	750H

L-shaped single bench desks with top access Type : A



D1ABLA0630A	3000W	600D	750H
D1ABLA0632A	3200W	600D	750H
D1ABLA0636A	3600W	600D	750H

D1ABLA0732A	3200W	750D	750H
D1ABLA0736A	3600W	750D	750H

L-shaped single bench desks Type : B

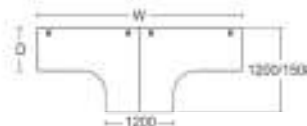

D1ABL0630B	3000W	600D	750H
D1ABL0632B	3200W	600D	750H
D1ABL0636B	3600W	600D	750H

D1ABL0732B	3200W	750D	750H
D1ABL0736B	3600W	750D	750H

L-shaped single bench desks with top access Type : B



D1ABLA0630B	3000W	600D	750H
D1ABLA0632B	3200W	600D	750H
D1ABLA0636B	3600W	600D	750H

D1ABLA0732B	3200W	750D	750H
D1ABLA0736B	3600W	750D	750H

SINGLE CONNECTOR DESK

Rectangle single connector desk

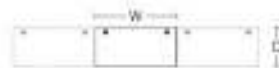

D1ACR0612	1200W	600D	750H
D1ACR0614	1400W	600D	750H
D1ACR0615	1500W	600D	750H
D1ACR0616	1600W	600D	750H
D1ACR0618	1800W	600D	750H

D1ACR0712	1200W	750D	750H
D1ACR0714	1400W	750D	750H
D1ACR0715	1500W	750D	750H
D1ACR0716	1600W	750D	750H
D1ACR0718	1800W	750D	750H

Rectangle single connector desk with top access



D1ACRA0612	1200W	600D	750H
D1ACRA0614	1400W	600D	750H
D1ACRA0615	1500W	600D	750H
D1ACRA0616	1600W	600D	750H
D1ACRA0618	1800W	600D	750H

D1ACRA0712	1200W	750D	750H
D1ACRA0714	1400W	750D	750H
D1ACRA0715	1500W	750D	750H
D1ACRA0716	1600W	750D	750H
D1ACRA0718	1800W	750D	750H

DOUBLE DESKS

Rectangle double desks

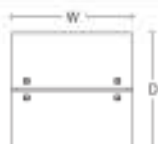

D1ADR1212	1200W	1240D	750H
D1ADR1214	1400W	1240D	750H
D1ADR1215	1500W	1240D	750H
D1ADR1216	1600W	1240D	750H
D1ADR1218	1800W	1240D	750H

D1ADR1512	1200W	1540D	750H
D1ADR1514	1400W	1540D	750H
D1ADR1515	1500W	1540D	750H
D1ADR1516	1600W	1540D	750H
D1ADR1518	1800W	1540D	750H

Rectangle double desks with top access

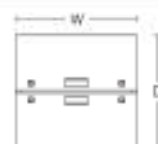

D1ADRA1212	1200W	1240D	750H
D1ADRA1214	1400W	1240D	750H
D1ADRA1215	1500W	1240D	750H
D1ADRA1216	1600W	1240D	750H
D1ADRA1218	1800W	1240D	750H

D1ADRA1512	1200W	1540D	750H
D1ADRA1514	1400W	1540D	750H
D1ADRA1515	1500W	1540D	750H
D1ADRA1516	1600W	1540D	750H
D1ADRA1518	1800W	1540D	750H

L-shaped double desks Type : A



D1ADL1215A	1500W	1240D	750H
D1ADL1216A	1600W	1240D	750H
D1ADL1218A	1800W	1240D	750H

D1ADL1516A	1600W	1540D	750H
D1ADL1518A	1800W	1540D	750H

L-shaped double desks with top access Type : A

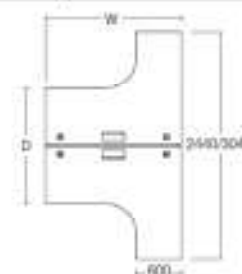

D1ADLA1215A	1500W	1240D	750H
D1ADLA1216A	1600W	1240D	750H
D1ADLA1218A	1800W	1240D	750H

D1ADLA1516A	1600W	1540D	750H
D1ADLA1518A	1800W	1540D	750H

L-shaped double desks Type : B

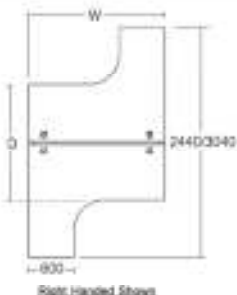

D1ADL1215L	1500W	1240D	750H
D1ADL1216L	1600W	1240D	750H
D1ADL1218L	1800W	1240D	750H

D1ADL1215R	1500W	1240D	750H
D1ADL1216R	1600W	1240D	750H
D1ADL1218R	1800W	1240D	750H

D1ADL1516L	1600W	1540D	750H
D1ADL1518L	1800W	1540D	750H

D1ADL1516R	1600W	1540D	750H
D1ADL1518R	1800W	1540D	750H

L-shaped double desks with top access Type : B



D1ADLA1215L	1500W	1240D	750H
D1ADLA1216L	1600W	1240D	750H
D1ADLA1218L	1800W	1240D	750H

D1ADLA1215R	1500W	1240D	750H
D1ADLA1216R	1600W	1240D	750H
D1ADLA1218R	1800W	1240D	750H

D1ADLA1516L	1600W	1540D	750H
D1ADLA1518L	1800W	1540D	750H

D1ADLA1516R	1600W	1540D	750H
D1ADLA1518R	1800W	1540D	750H

DOUBLE BENCH DESKS

Rectangle double bench desks



D1ABR1224	2400W	1240D	750H
D1ABR1228	2800W	1240D	750H
D1ABR1230	3000W	1240D	750H
D1ABR1232	3200W	1240D	750H
D1ABR1236	3600W	1240D	750H
<hr/>			
D1ABR1524	2400W	1540D	750H
D1ABR1528	2800W	1540D	750H
D1ABR1530	3000W	1540D	750H
D1ABR1532	3200W	1540D	750H
D1ABR1536	3600W	1540D	750H

Rectangle double bench desks with top access

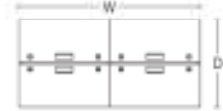
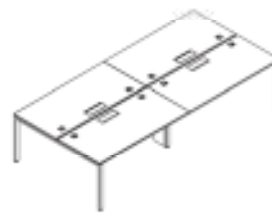

D1ABRA1224	2400W	1240D	750H
D1ABRA1228	2800W	1240D	750H
D1ABRA1230	3000W	1240D	750H
D1ABRA1232	3200W	1240D	750H
D1ABRA1236	3600W	1240D	750H
<hr/>			
D1ABRA1524	2400W	1540D	750H
D1ABRA1528	2800W	1540D	750H
D1ABRA1530	3000W	1540D	750H
D1ABRA1532	3200W	1540D	750H
D1ABRA1536	3600W	1540D	750H

36 DOUBLE CONNECTOR DESKS

Rectangle double connector desks

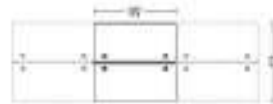

D1CR1212	1200W	1240D	750H
D1CR1214	1400W	1240D	750H
D1CR1215	1500W	1240D	750H
D1CR1216	1600W	1240D	750H
D1CR1218	1800W	1240D	750H
<hr/>			
D1CR1512	1200W	1540D	750H
D1CR1514	1400W	1540D	750H
D1CR1515	1500W	1540D	750H
D1CR1516	1600W	1540D	750H
D1CR1518	1800W	1540D	750H

Rectangle double connector desks with top access



D1CRA1212	1200W	1240D	750H
D1CRA1214	1400W	1240D	750H
D1CRA1215	1500W	1240D	750H
D1CRA1216	1600W	1240D	750H
D1CRA1218	1800W	1240D	750H
<hr/>			
D1CRA1512	1200W	1540D	750H
D1CRA1514	1400W	1540D	750H
D1CRA1515	1500W	1540D	750H
D1CRA1516	1600W	1540D	750H
D1CRA1518	1800W	1540D	750H

120-DEGREE CLUSTER DESKS

120-degree cluster desks



D1ACT1023	2370Dia.	1000L	750H
D1ACT1125	2540Dia.	1100L	750H
D1ACT1227	2720Dia.	1200L	750H

120-degree cluster desks with top access



D1ACTA1023	2370Dia.	1000L	750H
D1ACTA1125	2540Dia.	1100L	750H
D1ACTA1227	2720Dia.	1200L	750H

90-DEGREE CLUSTER DESKS

90-degree cluster desks

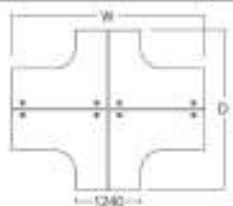

D1ACF2430	3040W	2440D	750H
D1ACF2432	3240W	2440D	750H
D1ACF2436	3640W	2440D	750H
<hr/>			
D1ACF3032	3240W	3040D	750H
D1ACF3036	3640W	3040D	750H

90-degree cluster desks with top access

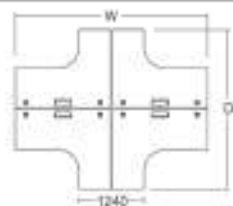
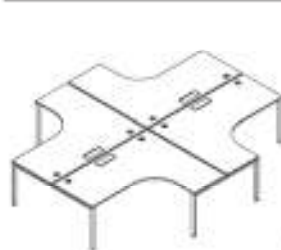

D1ACFA2430	3040W	2440D	750H
D1ACFA2432	3240W	2440D	750H
D1ACFA2436	3640W	2440D	750H
<hr/>			
D1ACFA3032	3240W	3040D	750H
D1ACFA3036	3640W	3040D	750H

SINGLE DESK WITH SUPPORT CABINET

Rectangle single desk with support cabinet

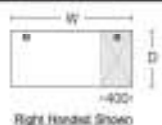

D1ADRP0614L	1400W	600D	750H
D1ADRP0615L	1500W	600D	750H
D1ADRP0616L	1600W	600D	750H
D1ADRP0618L	1800W	600D	750H
<hr/>			
D1ADRP0614R	1400W	600D	750H
D1ADRP0615R	1500W	600D	750H
D1ADRP0616R	1600W	600D	750H
D1ADRP0618R	1800W	600D	750H
<hr/>			
D1ADRP0714L	1400W	750D	750H
D1ADRP0715L	1500W	750D	750H
D1ADRP0716L	1600W	750D	750H
D1ADRP0718L	1800W	750D	750H
<hr/>			
D1ADRP0714R	1400W	750D	750H
D1ADRP0715R	1500W	750D	750H
D1ADRP0716R	1600W	750D	750H
D1ADRP0718R	1800W	750D	750H

Rectangle top access single desk with support cabinet



D1ADRAP0616L	1600W	600D	750H
D1ADRAP0618L	1800W	600D	750H
<hr/>			
D1ADRAP0616R	1600W	600D	750H
D1ADRAP0618R	1800W	600D	750H
<hr/>			
D1ADRAP0716L	1600W	750D	750H
D1ADRAP0718L	1800W	750D	750H
<hr/>			
D1ADRAP0716R	1600W	750D	750H
D1ADRAP0718R	1800W	750D	750H

L-shaped single desk with support cabinet



D1ADLP0616L	1600W	600D	750H
D1ADLP0618L	1800W	600D	750H
<hr/>			
D1ADLP0616R	1600W	600D	750H
D1ADLP0618R	1800W	600D	750H
<hr/>			
D1ADLP0716L	1600W	750D	750H
D1ADLP0718L	1800W	750D	750H
<hr/>			
D1ADLP0716R	1600W	750D	750H
D1ADLP0718R	1800W	750D	750H

L-shaped top access single desk with support cabinet



D1ADLAP0616L	1600W	600D	750H
D1ADLAP0618L	1800W	600D	750H
<hr/>			
D1ADLAP0616R	1600W	600D	750H
D1ADLAP0618R	1800W	600D	750H
<hr/>			
D1ADLAP0716L	1600W	750D	750H
D1ADLAP0718L	1800W	750D	750H
<hr/>			
D1ADLAP0716R	1600W	750D	750H
D1ADLAP0718R	1800W	750D	750H

SINGLE BENCH DESKS WITH SUPPORT CABINETS

Rectangle single bench desks with support cabinets

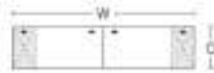

D1ABRP0628	2800W	600D	750H
D1ABRP0630	3000W	600D	750H
D1ABRP0632	3200W	600D	750H
D1ABRP0636	3600W	600D	750H
<hr/>			
D1ABRP0728	2800W	750D	750H
D1ABRP0730	3000W	750D	750H
D1ABRP0732	3200W	750D	750H
D1ABRP0736	3600W	750D	750H

Rectangle top access single bench desks with support cabinets

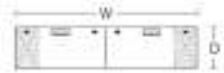

D1ABRAP0632	3200W	600D	750H
D1ABRAP0636	3600W	600D	750H
<hr/>			
D1ABRAP0732	3200W	750D	750H
D1ABRAP0736	3600W	750D	750H

L-shaped single bench desks with support cabinets

38

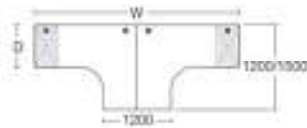

D1ABLP0632	3200W	600D	750H
D1ABLP0636	3600W	600D	750H
<hr/>			
D1ABLP0732	3200W	750D	750H
D1ABLP0736	3600W	750D	750H

L-shaped top access single bench desks with support cabinets

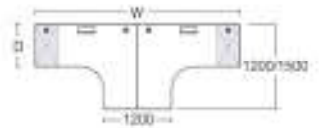

D1ABLAP0632	3200W	600D	750H
D1ABLAP0636	3600W	600D	750H
<hr/>			
D1ABLAP0732	3200W	750D	750H
D1ABLAP0736	3600W	750D	750H

DOUBLE DESKS WITH SUPPORT CABINETS

Rectangle double desks with support cabinets

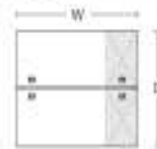

D1ADRP1214	1400W	1240D	750H
D1ADRP1215	1500W	1240D	750H
D1ADRP1216	1600W	1240D	750H
D1ADRP1218	1800W	1240D	750H
<hr/>			
D1ADRP1514	1400W	1540D	750H
D1ADRP1515	1500W	1540D	750H
D1ADRP1516	1600W	1540D	750H
D1ADRP1518	1800W	1540D	750H

Rectangle top access double desks with support cabinets

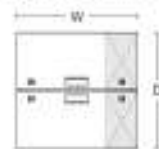

D1ADRAP1216	1600W	1240D	750H
D1ADRAP1218	1800W	1240D	750H
<hr/>			
D1ADRAP1516	1600W	1540D	750H
D1ADRAP1518	1800W	1540D	750H

L-shaped double desks with support cabinets

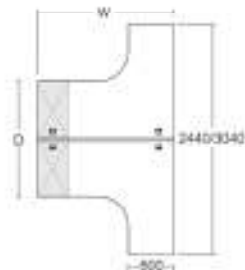

D1ADLP1216A	1600W	1240D	750H
D1ADLP1218A	1800W	1240D	750H
<hr/>			
D1ADLP1516A	1600W	1540D	750H
D1ADLP1518A	1800W	1540D	750H

L-shaped top access double desks with support cabinets

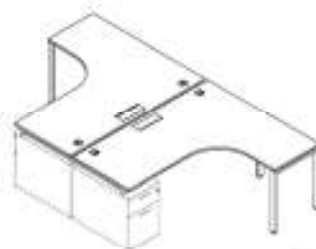

D1ADLAP1216A	1600W	1240D	750H
D1ADLAP1218A	1800W	1240D	750H
<hr/>			
D1ADLAP1516A	1600W	1540D	750H
D1ADLAP1518A	1800W	1540D	750H

DOUBLE BENCH DESKS WITH SUPPORT CABINETS

Rectangle double bench desks with support cabinets



D1BRP1228	2800W	1240D	750H
D1BRP1230	3000W	1240D	750H
D1BRP1232	3200W	1240D	750H
D1BRP1236	3600W	1240D	750H

D1BRP1528	2800W	1540D	750H
D1BRP1530	3000W	1540D	750H
D1BRP1532	3200W	1540D	750H
D1BRP1536	3600W	1540D	750H

Rectangle top access double bench desks with support cabinets

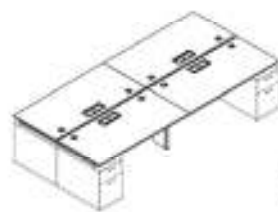

D1BRAP1232	3200W	1240D	750H
D1BRAP1236	3600W	1240D	750H

D1BRAP1532	3200W	1540D	750H
D1BRAP1536	3600W	1540D	750H

90-DEGREE CLUSTER DESKS WITH SUPPORT CABINETS

90-degree cluster desks with support cabinets

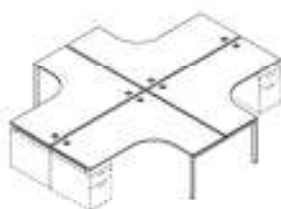

D1ACFP2432	3240W	2440D	750H
D1ACFP2436	3640W	2440D	750H

D1ACFP3032	3240W	3040D	750H
D1ACFP3036	3640W	3040D	750H

90-degree cluster desks with top access with support cabinets

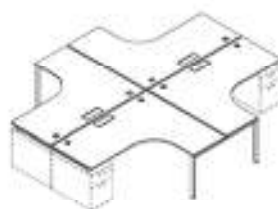

D1ACFAP2432	3240W	2440D	750H
D1ACFAP2436	3640W	2440D	750H

D1ACFAP3032	3240W	3040D	750H
D1ACFAP3036	3640W	3040D	750H

SUPPORT PEDESTAL AND SUPPORT CABINET

2-drawer support pedestal



D1PSA0604	400W	600D	640H
D1PSA0704	400W	750D	640H

3-drawer support pedestal



D1PSB0604	400W	600D	640H
D1PSB0704	400W	750D	640H

Open shelf with 2-drawer support cabinet



D1PSC0411L	1100W	400D	640H
D1PSC0411R	1100W	400D	640H
D1PSC0412L	1250W	400D	640H
D1PSC0412R	1250W	400D	640H

CPU with sliding door support cabinet

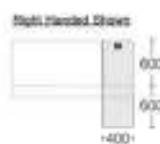

D1PSC0412L	1200W	400D	640H
D1PSC0412R	1200W	400D	640H

RETURN DESK

Single return desk



Can be used with executive desk.

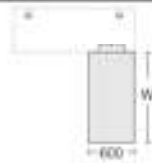

D1ARS0609	900W	600D	750H
D1ARS0612	1200W	600D	750H

Double return desk

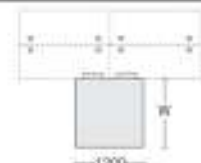

D1ARD1209	900W	1200D	750H
D1ARD1212	1200W	1200D	750H

Return desk with support pedestal



Can be used with executive desk.

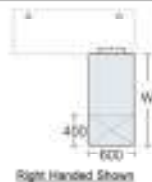

Right Handed Shown

D1RP0612L	1200W	600D	750H
D1RP0614L	1400W	600D	750H
D1RP0616L	1600W	600D	750H
D1RP0612R	1200W	600D	750H
D1RP0614R	1400W	600D	750H
D1RP0616R	1600W	600D	750H

EXTENSION TOP

Side top extension

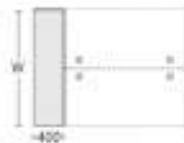

D1ES1200	1200W	400D	25H
D1ES1240	1240W	400D	25H
D1ES1500	1500W	400D	25H
D1ES1540	1540W	400D	25H

Lower top extension

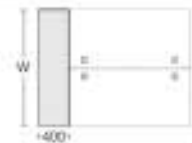

D1EL1200	1200W	400D	25H
D1EL1240	1240W	400D	25H
D1EL1500	1500W	400D	25H
D1EL1540	1540W	400D	25H

EXECUTIVE GROUP

Wooden top executive desk with top access



Non-Handed

D1AEDA0918	1800W	900D	750H
D1AEDA0920	2000W	900D	750H

Glass top executive desk



Installing Return On Right

D1AEDG0918L	1800W	900D	750H
D1AEDG0920L	2000W	900D	750H
D1AEDG0918R	1800W	900D	750H
D1AEDG0920R	2000W	900D	750H

Glass top return desk



D1ARG0609	900W	600D	750H
D1ARG0612	1200W	600D	750H

EXECUTIVE GROUP

Wooden top executive desk with support cabinet

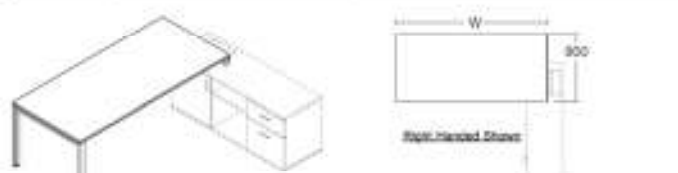

D1AEDP0918L	1800W	900D	750H
D1AEDP0920L	2000W	900D	750H
D1AEDP0918R	1800W	900D	750H
D1AEDP0920R	2000W	900D	750H

Glass top executive desk with support cabinet

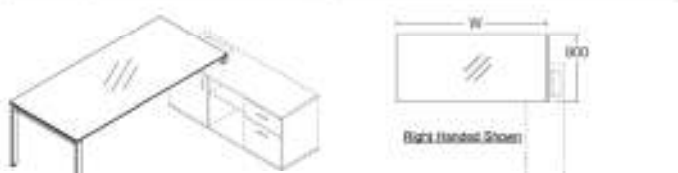

D1AEDGP0918L	1800W	900D	750H
D1AEDGP0920L	2000W	900D	750H
D1AEDGP0918R	1800W	900D	750H
D1AEDGP0920R	2000W	900D	750H

Executive support cabinet



D1EPS0515L	1500W	500D	640H
D1EPS0515R	1500W	500D	640H

MEETING AND CONFERENCE TABLES

Wooden top square meeting table



D1AMS1000	1000W	1000D	750H
D1AMS1200	1200W	1200D	750H
D1AMS1600	1600W	1600D	750H

Wooden top square meeting table with top access



D1AMSA1600	1600W	1600D	750H
------------	-------	-------	------

Glass top square meeting table



D1AMSG1000	1000W	1000D	750H
D1AMSG1200	1200W	1200D	750H
D1AMSG1600	1600W	1600D	750H

Wooden top rectangle meeting table



D1AMR1218	1800W	1200D	750H
D1AMR1220	2000W	1200D	750H
D1AMR1224	2400W	1200D	750H

Wooden top rectangle meeting table with top access



D1AMRA1218	1800W	1200D	750H
D1AMRA1220	2000W	1200D	750H
D1AMRA1224	2400W	1200D	750H

MEETING AND CONFERENCE TABLES

Glass top rectangle meeting table



D1AMRG1218	1800W	1200D	750H
D1AMRG1220	2000W	1200D	750H
D1AMRG1224	2400W	1200D	750H

Wooden top conference tables



D1ACT1236	3600W	1200D	750H
-----------	-------	-------	------

Wooden top conference tables with top access

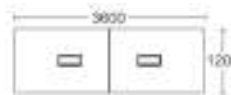
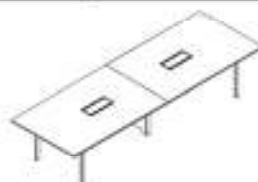

D1ACTA1236	3600W	1200D	750H
------------	-------	-------	------

Glass top conference tables

42

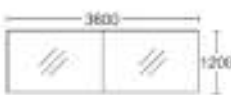

D1ACTG1236	3600W	1200D	750H
------------	-------	-------	------

Wooden top conference connector table



D1ACC1215	1500W	1200D	750H
-----------	-------	-------	------

Wooden top conference connector table with top access

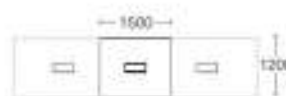
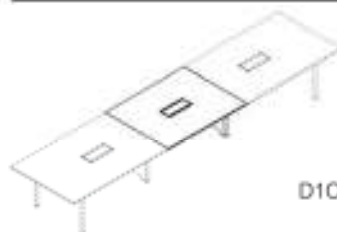

D1CCA1215	1500W	1200D	750H
-----------	-------	-------	------

Glass top conference connector table



D1ACCG1215	1500W	1200D	750H
------------	-------	-------	------

TRAINING DESKS

Training single desk



D1ATS0512	1200W	500D	750H
D1ATS0514	1400W	500D	750H
D1ATS0515	1500W	500D	750H
D1ATS0516	1600W	500D	750H
D1ATS0518	1800W	500D	750H
D1ATS0612	1200W	600D	750H
D1ATS0614	1400W	600D	750H
D1ATS0615	1500W	600D	750H
D1ATS0616	1600W	600D	750H
D1ATS0618	1800W	600D	750H

Training bench desks

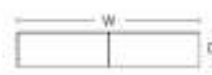

D1ATB0524	2400W	500D	750H
D1ATB0528	2800W	500D	750H
D1ATB0530	3000W	500D	750H
D1ATB0532	3200W	500D	750H
D1ATB0536	3600W	500D	750H
D1ATB0624	2400W	600D	750H
D1ATB0628	2800W	600D	750H
D1ATB0630	3000W	600D	750H
D1ATB0632	3200W	600D	750H
D1ATB0636	3600W	600D	750H

TRAINING DESKS

Training connector desk



D1ATC0512	1200W	500D	750H
D1ATC0514	1400W	500D	750H
D1ATC0515	1500W	500D	750H
D1ATC0516	1600W	500D	750H
D1ATC0518	1800W	500D	750H
<hr/>			
D1ATC0612	1200W	600D	750H
D1ATC0614	1400W	600D	750H
D1ATC0615	1500W	600D	750H
D1ATC0616	1600W	600D	750H
D1ATC0618	1800W	600D	750H

RECEPTION COUNTERS

Single reception counter

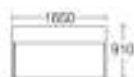

D1RCS0916 1650W 910D 1100H

Straight reception counter

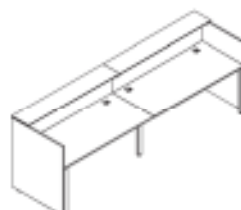

D1RCB0932 3250W 910D 1100H

43

Corner reception counter

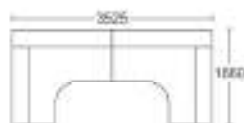

D1RCL1635 3525W 1660D 1100H

Connector reception counter

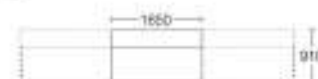

D1RCC0916 1650W 910D 1100H

Straight reception counters with cabinet



D1RCP1432 3250W 1410D 1100H

DESKS

SINGLE DESK

Rectangle single desk



D1BDR0612	1200W	600D	750H
D1BDR0614	1400W	600D	750H
D1BDR0615	1500W	600D	750H
D1BDR0616	1600W	600D	750H
D1BDR0618	1800W	600D	750H

D1BDR0712	1200W	750D	750H
D1BDR0714	1400W	750D	750H
D1BDR0715	1500W	750D	750H
D1BDR0716	1600W	750D	750H
D1BDR0718	1800W	750D	750H

Rectangle single desk with top access



D1BDRA0612	1200W	600D	750H
D1BDRA0614	1400W	600D	750H
D1BDRA0615	1500W	600D	750H
D1BDRA0616	1600W	600D	750H
D1BDRA0618	1800W	600D	750H

D1BDRA0712	1200W	750D	750H
D1BDRA0714	1400W	750D	750H
D1BDRA0715	1500W	750D	750H
D1BDRA0716	1600W	750D	750H
D1BDRA0718	1800W	750D	750H

44 L-shaped single desk

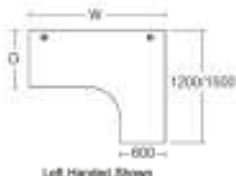

D1BDL0615L	1500W	600D	750H
D1BDL0616L	1600W	600D	750H
D1BDL0618L	1800W	600D	750H

D1BDL0615R	1500W	600D	750H
D1BDL0616R	1600W	600D	750H
D1BDL0618R	1800W	600D	750H

D1BDL0716L	1600W	750D	750H
D1BDL0718L	1800W	750D	750H

D1BDL0716R	1600W	750D	750H
D1BDL0718R	1800W	750D	750H

L-shaped single desk with top access



D1BDLA0615L	1500W	600D	750H
D1BDLA0616L	1600W	600D	750H
D1BDLA0618L	1800W	600D	750H

D1BDLA0615R	1500W	600D	750H
D1BDLA0616R	1600W	600D	750H
D1BDLA0618R	1800W	600D	750H

D1BDLA0716L	1600W	750D	750H
D1BDLA0718L	1800W	750D	750H

D1BDLA0716R	1600W	750D	750H
D1BDLA0718R	1800W	750D	750H

End desk

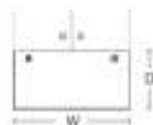

D1BDE0612	1240W	600D	750H
D1BDE0715	1540W	750D	750H

End desk with top access



D1BDEA0612	1240W	600D	750H
D1BDEA0715	1540W	750D	750H

SINGLE BENCH DESKS

Rectangle single bench desks

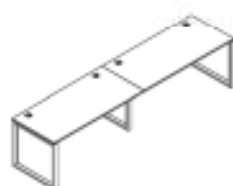

D1BBR0624	2400W	600D	750H
D1BBR0628	2800W	600D	750H
D1BBR0630	3000W	600D	750H
D1BBR0632	3200W	600D	750H
D1BBR0636	3600W	600D	750H
<hr/>			
D1BBR0724	2400W	750D	750H
D1BBR0728	2800W	750D	750H
D1BBR0730	3000W	750D	750H
D1BBR0732	3200W	750D	750H
D1BBR0736	3600W	750D	750H

Rectangle single bench desks with top access



D1BBRA0624	2400W	600D	750H
D1BBRA0628	2800W	600D	750H
D1BBRA0630	3000W	600D	750H
D1BBRA0632	3200W	600D	750H
D1BBRA0636	3600W	600D	750H
<hr/>			
D1BBRA0724	2400W	750D	750H
D1BBRA0728	2800W	750D	750H
D1BBRA0730	3000W	750D	750H
D1BBRA0732	3200W	750D	750H
D1BBRA0736	3600W	750D	750H

L-shaped single bench desks Type : A

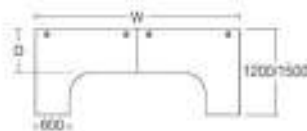

D1BBL0630A	3000W	600D	750H
D1BBL0632A	3200W	600D	750H
D1BBL0636A	3600W	600D	750H
<hr/>			
D1BBL0732A	3200W	750D	750H
D1BBL0736A	3600W	750D	750H

L-shaped single bench desks with top access Type : A

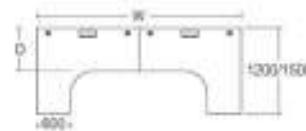

D1BBLA0630A	3000W	600D	750H
D1BBLA0632A	3200W	600D	750H
D1BBLA0636A	3600W	600D	750H
<hr/>			
D1BBLA0732A	3200W	750D	750H
D1BBLA0736A	3600W	750D	750H

45

L-shaped single bench desks Type : B

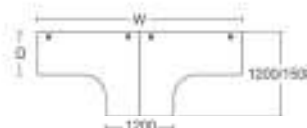

D1BBL0630B	3000W	600D	750H
D1BBL0632B	3200W	600D	750H
D1BBL0636B	3600W	600D	750H
<hr/>			
D1BBL0732B	3200W	750D	750H
D1BBL0736B	3600W	750D	750H

L-shaped single bench desks with top access Type : B



D1BBLA0630B	3000W	600D	750H
D1BBLA0632B	3200W	600D	750H
D1BBLA0636B	3600W	600D	750H
<hr/>			
D1BBLA0732B	3200W	750D	750H
D1BBLA0736B	3600W	750D	750H

SINGLE CONNECTOR DESK

Rectangle single connector desk

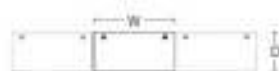

D1BCR0612	1200W	600D	750H
D1BCR0614	1400W	600D	750H
D1BCR0615	1500W	600D	750H
D1BCR0616	1600W	600D	750H
D1BCR0618	1800W	600D	750H
<hr/>			
D1BCR0712	1200W	750D	750H
D1BCR0714	1400W	750D	750H
D1BCR0715	1500W	750D	750H
D1BCR0716	1600W	750D	750H
D1BCR0718	1800W	750D	750H

Rectangle single connector desk with top access



D1BCRA0612	1200W	600D	750H
D1BCRA0614	1400W	600D	750H
D1BCRA0615	1500W	600D	750H
D1BCRA0616	1600W	600D	750H
D1BCRA0618	1800W	600D	750H
<hr/>			
D1BCRA0712	1200W	750D	750H
D1BCRA0714	1400W	750D	750H
D1BCRA0715	1500W	750D	750H
D1BCRA0716	1600W	750D	750H
D1BCRA0718	1800W	750D	750H

DOUBLE DESKS

Rectangle double desks

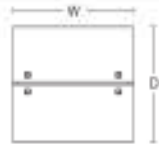
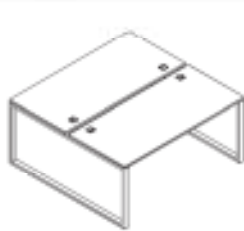

D1BDR1212	1200W	1240D	750H
D1BDR1214	1400W	1240D	750H
D1BDR1215	1500W	1240D	750H
D1BDR1216	1600W	1240D	750H
D1BDR1218	1800W	1240D	750H
<hr/>			
D1BDR1512	1200W	1540D	750H
D1BDR1514	1400W	1540D	750H
D1BDR1515	1500W	1540D	750H
D1BDR1516	1600W	1540D	750H
D1BDR1518	1800W	1540D	750H

Rectangle double desks with top access

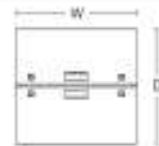
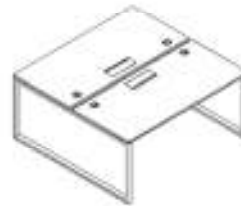

D1BDRA1212	1200W	1240D	750H
D1BDRA1214	1400W	1240D	750H
D1BDRA1215	1500W	1240D	750H
D1BDRA1216	1600W	1240D	750H
D1BDRA1218	1800W	1240D	750H
<hr/>			
D1BDRA1512	1200W	1540D	750H
D1BDRA1514	1400W	1540D	750H
D1BDRA1515	1500W	1540D	750H
D1BDRA1516	1600W	1540D	750H
D1BDRA1518	1800W	1540D	750H

L-shaped double desks Type : A

46

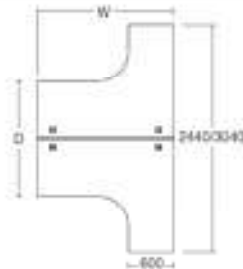

D1BDL1215A	1500W	1240D	750H
D1BDL1216A	1600W	1240D	750H
D1BDL1218A	1800W	1240D	750H
<hr/>			
D1BDL1516A	1600W	1540D	750H
D1BDL1518A	1800W	1540D	750H

L-shaped double desks with top access Type : A

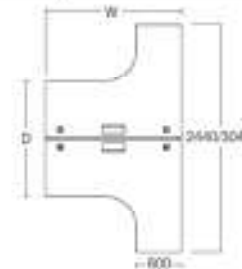

D1BDLA1215A	1500W	1240D	750H
D1BDLA1216A	1600W	1240D	750H
D1BDLA1218A	1800W	1240D	750H
<hr/>			
D1BDLA1516A	1600W	1540D	750H
D1BDLA1518A	1800W	1540D	750H

L-shaped double desks Type : B

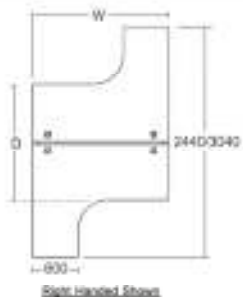

D1BDL1215L	1500W	1240D	750H
D1BDL1216L	1600W	1240D	750H
D1BDL1218L	1800W	1240D	750H
<hr/>			
D1BDL1215R	1500W	1240D	750H
D1BDL1216R	1600W	1240D	750H
D1BDL1218R	1800W	1240D	750H
<hr/>			
D1BDL1516L	1600W	1540D	750H
D1BDL1518L	1800W	1540D	750H
<hr/>			
D1BDL1516R	1600W	1540D	750H
D1BDL1518R	1800W	1540D	750H

L-shaped double desks with top access Type : B

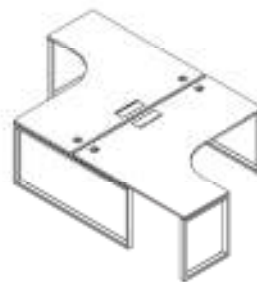

D1BDLA1215L	1500W	1240D	750H
D1BDLA1216L	1600W	1240D	750H
D1BDLA1218L	1800W	1240D	750H
<hr/>			
D1BDLA1215R	1500W	1240D	750H
D1BDLA1216R	1600W	1240D	750H
D1BDLA1218R	1800W	1240D	750H
<hr/>			
D1BDLA1516L	1600W	1540D	750H
D1BDLA1518L	1800W	1540D	750H
<hr/>			
D1BDLA1516R	1600W	1540D	750H
D1BDLA1518R	1800W	1540D	750H

DOUBLE BENCH DESKS

Rectangle double bench desks



D1BBR1224	2400W	1240D	750H
D1BBR1228	2800W	1240D	750H
D1BBR1230	3000W	1240D	750H
D1BBR1232	3200W	1240D	750H
D1BBR1236	3600W	1240D	750H
<hr/>			
D1BBR1524	2400W	1540D	750H
D1BBR1528	2800W	1540D	750H
D1BBR1530	3000W	1540D	750H
D1BBR1532	3200W	1540D	750H
D1BBR1536	3600W	1540D	750H

Rectangle double bench desks with top access

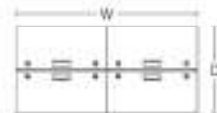

D1BBRA1224	2400W	1240D	750H
D1BBRA1228	2800W	1240D	750H
D1BBRA1230	3000W	1240D	750H
D1BBRA1232	3200W	1240D	750H
D1BBRA1236	3600W	1240D	750H
<hr/>			
D1BBRA1524	2400W	1540D	750H
D1BBRA1528	2800W	1540D	750H
D1BBRA1530	3000W	1540D	750H
D1BBRA1532	3200W	1540D	750H
D1BBRA1536	3600W	1540D	750H

DOUBLE CONNECTOR DESKS

Rectangle double connector desks



D1CR1212	1200W	1240D	750H
D1CR1214	1400W	1240D	750H
D1CR1215	1500W	1240D	750H
D1CR1216	1600W	1240D	750H
D1CR1218	1800W	1240D	750H
<hr/>			
D1CR1512	1200W	1540D	750H
D1CR1514	1400W	1540D	750H
D1CR1515	1500W	1540D	750H
D1CR1516	1600W	1540D	750H
D1CR1518	1800W	1540D	750H

Rectangle double connector desks with top access



D1CRA1212	1200W	1240D	750H
D1CRA1214	1400W	1240D	750H
D1CRA1215	1500W	1240D	750H
D1CRA1216	1600W	1240D	750H
D1CRA1218	1800W	1240D	750H
<hr/>			
D1CRA1512	1200W	1540D	750H
D1CRA1514	1400W	1540D	750H
D1CRA1515	1500W	1540D	750H
D1CRA1516	1600W	1540D	750H
D1CRA1518	1800W	1540D	750H

120-DEGREE CLUSTER DESKS

120-degree cluster desks

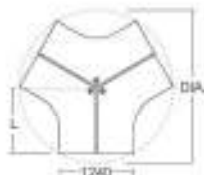

D1BCT1023	2370Dia.	1000L	750H
D1BCT1125	2540Dia.	1100L	750H
D1BCT1227	2720Dia.	1200L	750H

120-degree cluster desks with top access



D1BCTA1023	2370Dia.	1000L	750H
D1BCTA1125	2540Dia.	1100L	750H
D1BCTA1227	2720Dia.	1200L	750H

90-DEGREE CLUSTER DESKS

90-degree cluster desks

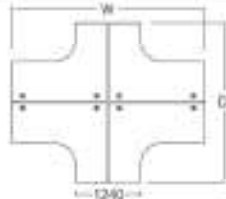
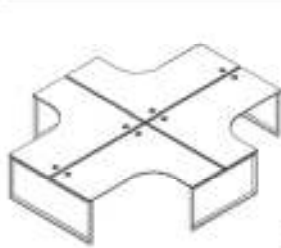

D1BCF2430	3040W	2440D	750H
D1BCF2432	3240W	2440D	750H
D1BCF2436	3640W	2440D	750H
<hr/>			
D1BCF3032	3240W	3040D	750H
D1BCF3036	3640W	3040D	750H

90-degree cluster desks with top access

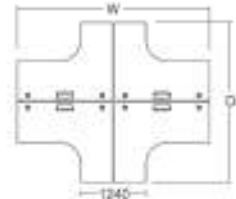
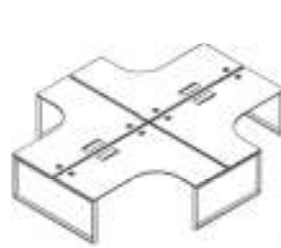

D1BCFA2430	3040W	2440D	750H
D1BCFA2432	3240W	2440D	750H
D1BCFA2436	3640W	2440D	750H
<hr/>			
D1BCFA3032	3240W	3040D	750H
D1BCFA3036	3640W	3040D	750H

SINGLE DESK WITH SUPPORT CABINET

Rectangle single desk with support cabinet

48

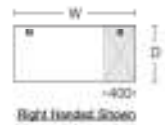

D1BDRP0614L	1400W	600D	750H
D1BDRP0615L	1500W	600D	750H
D1BDRP0616L	1600W	600D	750H
D1BDRP0618L	1800W	600D	750H
<hr/>			
D1BDRP0614R	1400W	600D	750H
D1BDRP0615R	1500W	600D	750H
D1BDRP0616R	1600W	600D	750H
D1BDRP0618R	1800W	600D	750H
<hr/>			
D1BDRP0714L	1400W	750D	750H
D1BDRP0715L	1500W	750D	750H
D1BDRP0716L	1600W	750D	750H
D1BDRP0718L	1800W	750D	750H
<hr/>			
D1BDRP0714R	1400W	750D	750H
D1BDRP0715R	1500W	750D	750H
D1BDRP0716R	1600W	750D	750H
D1BDRP0718R	1800W	750D	750H

Rectangle top access single desk with support cabinet



D1BDRAP0616L	1600W	600D	750H
D1BDRAP0618L	1800W	600D	750H
<hr/>			
D1BDRAP0616R	1600W	600D	750H
D1BDRAP0618R	1800W	600D	750H
<hr/>			
D1BDRAP0716L	1600W	750D	750H
D1BDRAP0718L	1800W	750D	750H
<hr/>			
D1BDRAP0716R	1600W	750D	750H
D1BDRAP0718R	1800W	750D	750H

L-shaped single desk with support cabinet

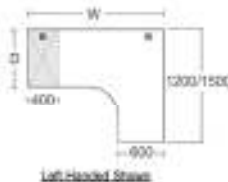

D1BDLP0616L	1600W	600D	750H
D1BDLP0618L	1800W	600D	750H
<hr/>			
D1BDLP0616R	1600W	600D	750H
D1BDLP0618R	1800W	600D	750H
<hr/>			
D1BDLP0716L	1600W	750D	750H
D1BDLP0718L	1800W	750D	750H
<hr/>			
D1BDLP0716R	1600W	750D	750H
D1BDLP0718R	1800W	750D	750H

L-shaped top access single desk with support cabinet



D1BDLAP0616L	1600W	600D	750H
D1BDLAP0618L	1800W	600D	750H
<hr/>			
D1BDLAP0616R	1600W	600D	750H
D1BDLAP0618R	1800W	600D	750H
<hr/>			
D1BDLAP0716L	1600W	750D	750H
D1BDLAP0718L	1800W	750D	750H
<hr/>			
D1BDLAP0716R	1600W	750D	750H
D1BDLAP0718R	1800W	750D	750H

SINGLE BENCH DESKS WITH SUPPORT CABINETS

Rectangle single bench desks with support cabinets



D1BBRP0628	2800W	600D	750H
D1BBRP0630	3000W	600D	750H
D1BBRP0632	3200W	600D	750H
D1BBRP0636	3600W	600D	750H
<hr/>			
D1BBRP0728	2800W	750D	750H
D1BBRP0730	3000W	750D	750H
D1BBRP0732	3200W	750D	750H
D1BBRP0736	3600W	750D	750H

Rectangle top access single bench desks with support cabinets

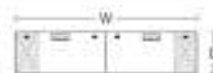

D1BBRAP0632	3200W	600D	750H
D1BBRAP0636	3600W	600D	750H
<hr/>			
D1BBRAP0732	3200W	750D	750H
D1BBRAP0736	3600W	750D	750H

L-shaped single bench desks with support cabinets

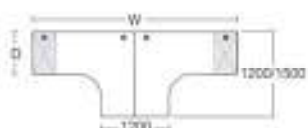
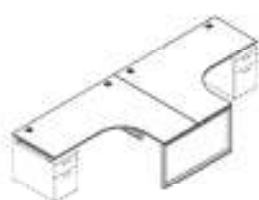

D1BBLP0632	3200W	600D	750H
D1BBLP0636	3600W	600D	750H
<hr/>			
D1BBLP0732	3200W	750D	750H
D1BBLP0736	3600W	750D	750H

L-shaped top access single bench desks with support cabinets



D1BBLAP0632	3200W	600D	750H
D1BBLAP0636	3600W	600D	750H
<hr/>			
D1BBLAP0732	3200W	750D	750H
D1BBLAP0736	3600W	750D	750H

DOUBLE DESKS WITH SUPPORT CABINETS

Rectangle double desks with support cabinets

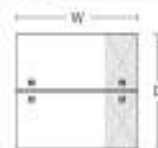

D1BDRP1214	1400W	1240D	750H
D1BDRP1215	1500W	1240D	750H
D1BDRP1216	1600W	1240D	750H
D1BDRP1218	1800W	1240D	750H
<hr/>			
D1BDRP1514	1400W	1540D	750H
D1BDRP1515	1500W	1540D	750H
D1BDRP1516	1600W	1540D	750H
D1BDRP1518	1800W	1540D	750H

Rectangle top access double desks with support cabinets

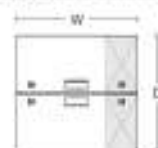
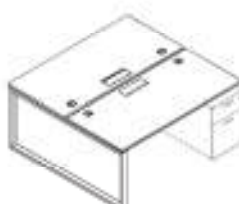

D1BDRAP1216	1600W	1240D	750H
D1BDRAP1218	1800W	1240D	750H
<hr/>			
D1BDRAP1516	1600W	1540D	750H
D1BDRAP1518	1800W	1540D	750H

L-shaped double desks with support cabinets

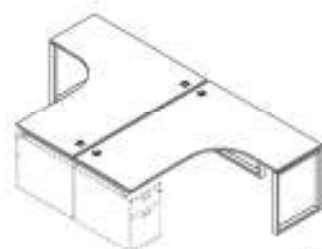

D1BDLP1216A	1600W	1240D	750H
D1BDLP1218A	1800W	1240D	750H
<hr/>			
D1BDLP1516A	1600W	1540D	750H
D1BDLP1518A	1800W	1540D	750H

L-shaped top access double desks with support cabinets



D1BDLAP1216A	1600W	1240D	750H
D1BDLAP1218A	1800W	1240D	750H
<hr/>			
D1BDLAP1516A	1600W	1540D	750H
D1BDLAP1518A	1800W	1540D	750H

DOUBLE BENCH DESKS WITH SUPPORT CABINETS

Rectangle double bench desks with support cabinets



D1BRP1228	2800W	1240D	750H
D1BRP1230	3000W	1240D	750H
D1BRP1232	3200W	1240D	750H
D1BRP1236	3600W	1240D	750H
<hr/>			
D1BRP1528	2800W	1540D	750H
D1BRP1530	3000W	1540D	750H
D1BRP1532	3200W	1540D	750H
D1BRP1536	3600W	1540D	750H

Rectangle top access double bench desks with support cabinets

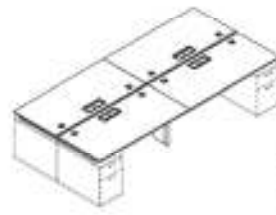

D1BRAP1232	3200W	1240D	750H
D1BRAP1236	3600W	1240D	750H
<hr/>			
D1BRAP1532	3200W	1540D	750H
D1BRAP1536	3600W	1540D	750H

90-DEGREE CLUSTER DESKS WITH SUPPORT CABINETS

90-degree cluster desks with support cabinets

50

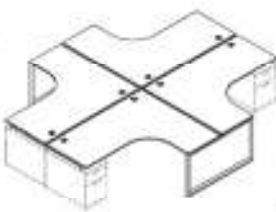

D1BCFP2432	3240W	2440D	750H
D1BCFP2436	3640W	2440D	750H
<hr/>			
D1BCFP3032	3240W	3040D	750H
D1BCFP3036	3640W	3040D	750H

90-degree cluster desks with top access with support cabinets

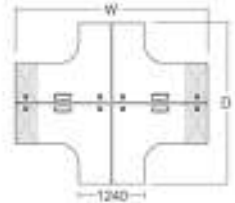
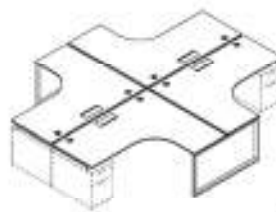

D1BCFAP2432	3240W	2440D	750H
D1BCFAP2436	3640W	2440D	750H
<hr/>			
D1BCFAP3032	3240W	3040D	750H
D1BCFAP3036	3640W	3040D	750H

SUPPORT PEDESTAL AND SUPPORT CABINET

2-drawer support pedestal



D1PSA0604	400W	600D	640H
D1PSA0704	400W	750D	640H

3-drawer support pedestal

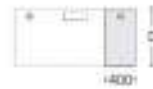

D1PSB0604	400W	600D	640H
D1PSB0704	400W	750D	640H

Open shelf with 2-drawer support cabinet

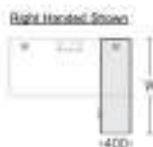

D1PSC0411L	1100W	400D	640H
D1PSC0411R	1100W	400D	640H
<hr/>			
D1PSC0412L	1250W	400D	640H
D1PSC0412R	1250W	400D	640H

CPU with sliding door support cabinet

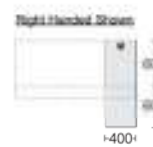

D1PSC0412L	1200W	400D	640H
D1PSC0412R	1200W	400D	640H

RETURN DESK

Single return desk



Can be used with executive desk.

D1BR50609	900W	600D	750H
D1BR50612	1200W	600D	750H

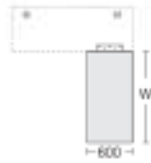

Double return desk



D1BRD1209	900W	1200D	750H
D1BRD1212	1200W	1200D	750H

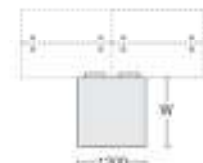

Return desk with support pedestal



Can be used with executive desk.

D1RP0612L	1200W	600D	750H
D1RP0614L	1400W	600D	750H
D1RP0616L	1600W	600D	750H
D1RP0612R	1200W	600D	750H
D1RP0614R	1400W	600D	750H
D1RP0616R	1600W	600D	750H



EXTENSION TOP

Side top extension



D1ES1200	1200W	400D	25H
D1ES1240	1240W	400D	25H
D1ES1500	1500W	400D	25H
D1ES1540	1540W	400D	25H

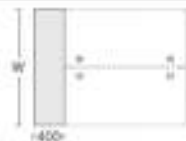

Lower top extension



D1EL1200	1200W	400D	25H
D1EL1240	1240W	400D	25H
D1EL1500	1500W	400D	25H
D1EL1540	1540W	400D	25H

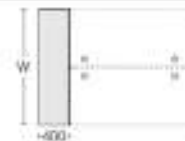

EXECUTIVE GROUP

Wooden top executive desk with top access



D1BEDA0918	1800W	900D	750H
D1BEDA0920	2000W	900D	750H



Glass top executive desk



D1BEDG0918L	1800W	900D	750H
D1BEDG0920L	2000W	900D	750H
D1BEDG0918R	1800W	900D	750H
D1BEDG0920R	2000W	900D	750H



Glass top return desk



D1BRG0609	900W	600D	750H
D1BRG0612	1200W	600D	750H



MEETING AND CONFERENCE TABLES

Wooden top rectangle meeting table

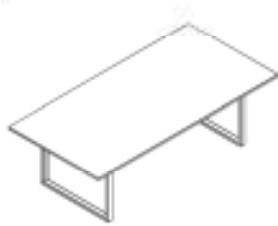

D1BMR1218	1800W	1200D	750H
D1BMR1220	2000W	1200D	750H
D1BMR1224	2400W	1200D	750H

Wooden top rectangle meeting table with top access



D1BMRA1218	1800W	1200D	750H
D1BMRA1220	2000W	1200D	750H
D1BMRA1224	2400W	1200D	750H

Glass top rectangle meeting table



D1BMRG1218	1800W	1200D	750H
D1BMRG1220	2000W	1200D	750H
D1BMRG1224	2400W	1200D	750H

52

Wooden top conference tables



D1BCT1236	3600W	1200D	750H
-----------	-------	-------	------

Wooden top conference tables with top access

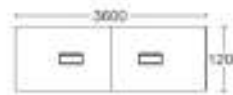
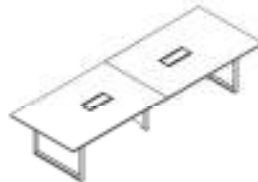

D1BCTA1236	3600W	1200D	750H
------------	-------	-------	------

Glass top conference tables



D1BCTG1236	3600W	1200D	750H
------------	-------	-------	------

Wooden top conference connector table

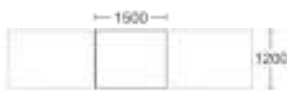

D1BCC1215	1500W	1200D	750H
-----------	-------	-------	------

Wooden top conference connector table with top access

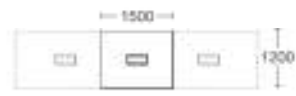

D1CCA1215	1500W	1200D	750H
-----------	-------	-------	------

Glass top conference connector table



D1BCCG1215	1500W	1200D	750H
------------	-------	-------	------

TRAINING DESKS

Training single desk

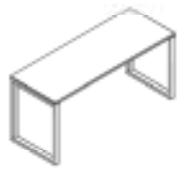

D1BTS0612	1200W	600D	750H
D1BTS0614	1400W	600D	750H
D1BTS0615	1500W	600D	750H
D1BTS0616	1600W	600D	750H
D1BTS0618	1800W	600D	750H

Training bench desks



D1BTB0624	2400W	600D	750H
D1BTB0628	2800W	600D	750H
D1BTB0630	3000W	600D	750H
D1BTB0632	3200W	600D	750H
D1BTB0636	3600W	600D	750H

Training connector desk

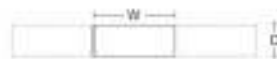

D1BTC0612	1200W	600D	750H
D1BTC0614	1400W	600D	750H
D1BTC0615	1500W	600D	750H
D1BTC0616	1600W	600D	750H
D1BTC0618	1800W	600D	750H

SCREENS

FRONT SCREEN FOR SINGLE DESK

Front screen for single desk (Wooden screen)



D1SSDW0312	1200W	16D	300H
D1SSDW0314	1400W	16D	300H
D1SSDW0315	1500W	16D	300H
D1SSDW0316	1600W	16D	300H
D1SSDW0318	1800W	16D	300H

D1SSDW0412	1200W	16D	400H
D1SSDW0414	1400W	16D	400H
D1SSDW0415	1500W	16D	400H
D1SSDW0416	1600W	16D	400H
D1SSDW0418	1800W	16D	400H

54

For End desk :

D1SSDW0301	1240W	16D	300H
D1SSDW0302	1540W	16D	300H

D1SSDW0401	1240W	16D	400H
D1SSDW0402	1540W	16D	400H

Front screen for single desk (Fabric screen)



D1SSDF0312	1200W	16D	300H
D1SSDF0314	1400W	16D	300H
D1SSDF0315	1500W	16D	300H
D1SSDF0316	1600W	16D	300H
D1SSDF0318	1800W	16D	300H

D1SSDF0412	1200W	16D	400H
D1SSDF0414	1400W	16D	400H
D1SSDF0415	1500W	16D	400H
D1SSDF0416	1600W	16D	400H
D1SSDF0418	1800W	16D	400H

For End desk :

D1SSDF0301	1240W	16D	300H
D1SSDF0302	1540W	16D	300H

D1SSDF0401	1240W	16D	400H
D1SSDF0402	1540W	16D	400H

Front screen for single desk (Glass screen)

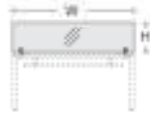

D1SSDG0312	1200W	6D	300H
D1SSDG0314	1400W	6D	300H
D1SSDG0315	1500W	6D	300H
D1SSDG0316	1600W	6D	300H
D1SSDG0318	1800W	6D	300H

D1SSDG0412	1200W	6D	400H
D1SSDG0414	1400W	6D	400H
D1SSDG0415	1500W	6D	400H
D1SSDG0416	1600W	6D	400H
D1SSDG0418	1800W	6D	400H

For End desk :

D1SSDG0301	1240W	6D	300H
D1SSDG0302	1540W	6D	300H

D1SSDG0401	1240W	6D	400H
D1SSDG0402	1540W	6D	400H

FRONT SCREEN FOR SINGLE DESK

Front screen for single bench desks (Wooden screen)



D1SSBW0324	2400W	16D	300H
D1SSBW0328	2800W	16D	300H
D1SSBW0330	3000W	16D	300H
D1SSBW0332	3200W	16D	300H
D1SSBW0336	3600W	16D	300H
<hr/>			
D1SSBW0424	2400W	16D	400H
D1SSBW0428	2800W	16D	400H
D1SSBW0430	3000W	16D	400H
D1SSBW0432	3200W	16D	400H
D1SSBW0436	3600W	16D	400H

Front screen for single bench desks (Fabric screen)



D1SSBF0324	2400W	16D	300H
D1SSBF0328	2800W	16D	300H
D1SSBF0330	3000W	16D	300H
D1SSBF0332	3200W	16D	300H
D1SSBF0336	3600W	16D	300H
<hr/>			
D1SSBF0424	2400W	16D	400H
D1SSBF0428	2800W	16D	400H
D1SSBF0430	3000W	16D	400H
D1SSBF0432	3200W	16D	400H
D1SSBF0436	3600W	16D	400H

Front screen for single connector desk (Wooden screen)



D1SSCW0312	1200W	16D	300H
D1SSCW0314	1400W	16D	300H
D1SSCW0315	1500W	16D	300H
D1SSCW0316	1600W	16D	300H
D1SSCW0318	1800W	16D	300H
<hr/>			
D1SSCW0412	1200W	16D	400H
D1SSCW0414	1400W	16D	400H
D1SSCW0415	1500W	16D	400H
D1SSCW0416	1600W	16D	400H
D1SSCW0418	1800W	16D	400H

Front screen for single connector desk (Fabric screen)



D1SSCF0312	1200W	16D	300H
D1SSCF0314	1400W	16D	300H
D1SSCF0315	1500W	16D	300H
D1SSCF0316	1600W	16D	300H
D1SSCF0318	1800W	16D	300H
<hr/>			
D1SSCF0412	1200W	16D	400H
D1SSCF0414	1400W	16D	400H
D1SSCF0415	1500W	16D	400H
D1SSCF0416	1600W	16D	400H
D1SSCF0418	1800W	16D	400H

FRONT SCREEN FOR DOUBLE DESKS

Front screen for double desks (Wooden screen)



D1SDDW0312	1200W	16D	300H
D1SDDW0314	1400W	16D	300H
D1SDDW0315	1500W	16D	300H
D1SDDW0316	1600W	16D	300H
D1SDDW0318	1800W	16D	300H
<hr/>			
D1SDDW0412	1200W	16D	400H
D1SDDW0414	1400W	16D	400H
D1SDDW0415	1500W	16D	400H
D1SDDW0416	1600W	16D	400H
D1SDDW0418	1800W	16D	400H

Front screen for double desks (Fabric screen)



D1SDDF0312	1200W	16D	300H
D1SDDF0314	1400W	16D	300H
D1SDDF0315	1500W	16D	300H
D1SDDF0316	1600W	16D	300H
D1SDDF0318	1800W	16D	300H
<hr/>			
D1SDDF0412	1200W	16D	400H
D1SDDF0414	1400W	16D	400H
D1SDDF0415	1500W	16D	400H
D1SDDF0416	1600W	16D	400H
D1SDDF0418	1800W	16D	400H

FRONT SCREEN FOR DOUBLE DESKS

Front screen for double desks (Glass screen)



D1SDDG0312	1200W	6D	300H
D1SDDG0314	1400W	6D	300H
D1SDDG0315	1500W	6D	300H
D1SDDG0316	1600W	6D	300H
D1SDDG0318	1800W	6D	300H
<hr/>			
D1SDDG0412	1200W	6D	400H
D1SDDG0414	1400W	6D	400H
D1SDDG0415	1500W	6D	400H
D1SDDG0416	1600W	6D	400H
D1SDDG0418	1800W	6D	400H

56 Front screen for double bench desks (Wooden screen)

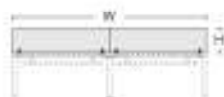

D1SDBW0324	2400W	16D	300H
D1SDBW0328	2800W	16D	300H
D1SDBW0330	3000W	16D	300H
D1SDBW0332	3200W	16D	300H
D1SDBW0336	3600W	16D	300H
<hr/>			
D1SDBW0424	2400W	16D	400H
D1SDBW0428	2800W	16D	400H
D1SDBW0430	3000W	16D	400H
D1SDBW0432	3200W	16D	400H
D1SDBW0436	3600W	16D	400H

Front screen for double bench desks (Fabric screen)

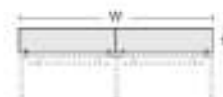
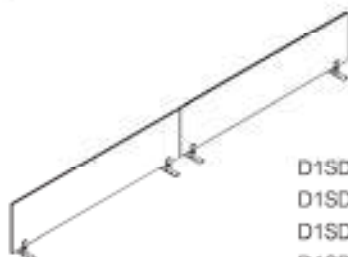

D1SDBF0324	2400W	16D	300H
D1SDBF0328	2800W	16D	300H
D1SDBF0330	3000W	16D	300H
D1SDBF0332	3200W	16D	300H
D1SDBF0336	3600W	16D	300H
<hr/>			
D1SDBF0424	2400W	16D	400H
D1SDBF0428	2800W	16D	400H
D1SDBF0430	3000W	16D	400H
D1SDBF0432	3200W	16D	400H
D1SDBF0436	3600W	16D	400H

Front screen for double connector desks (Wooden screen)



D1SDCW0312	1200W	16D	300H
D1SDCW0314	1400W	16D	300H
D1SDCW0315	1500W	16D	300H
D1SDCW0316	1600W	16D	300H
D1SDCW0318	1800W	16D	300H
<hr/>			
D1SDCW0412	1200W	16D	400H
D1SDCW0414	1400W	16D	400H
D1SDCW0415	1500W	16D	400H
D1SDCW0416	1600W	16D	400H
D1SDCW0418	1800W	16D	400H

Front screen for double connector desks (Fabric screen)



D1SDCF0312	1200W	16D	300H
D1SDCF0314	1400W	16D	300H
D1SDCF0315	1500W	16D	300H
D1SDCF0316	1600W	16D	300H
D1SDCF0318	1800W	16D	300H
<hr/>			
D1SDCF0412	1200W	16D	400H
D1SDCF0414	1400W	16D	400H
D1SDCF0415	1500W	16D	400H
D1SDCF0416	1600W	16D	400H
D1SDCF0418	1800W	16D	400H

FRONT SCREEN FOR 120-DEGREE CLUSTER DESKS

Front screen for 120-degree cluster desks (Wooden screen)

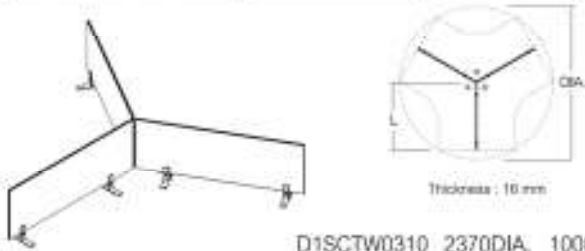

D1SCTW0310	2370DIA.	1000L	300H
D1SCTW0311	2540DIA.	1100L	300H
D1SCTW0312	2720DIA.	1200L	300H
<hr/>			
D1SCTW0410	2370DIA.	1000L	400H
D1SCTW0411	2540DIA.	1100L	400H
D1SCTW0412	2720DIA.	1200L	400H

Front screen for 120-degree cluster desks (Fabric screen)

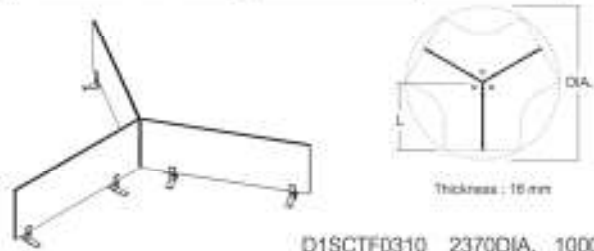

D1SCTF0310	2370DIA.	1000L	300H
D1SCTF0311	2540DIA.	1100L	300H
D1SCTF0312	2720DIA.	1200L	300H
<hr/>			
D1SCTF0410	2370DIA.	1000L	400H
D1SCTF0411	2540DIA.	1100L	400H
D1SCTF0412	2720DIA.	1200L	400H

Front screen for 120-degree cluster desks (Glass screen)

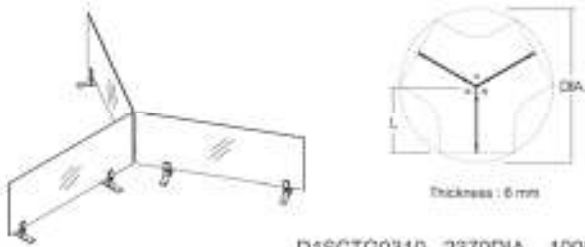

D1SCTG0310	2370DIA.	1000L	300H
D1SCTG0311	2540DIA.	1100L	300H
D1SCTG0312	2720DIA.	1200L	300H
<hr/>			
D1SCTG0410	2370DIA.	1000L	400H
D1SCTG0411	2540DIA.	1100L	400H
D1SCTG0412	2720DIA.	1200L	400H

FRONT SCREEN FOR 90-DEGREE CLUSTER DESKS

Front screen for 90-degree cluster desks (Wooden screen)

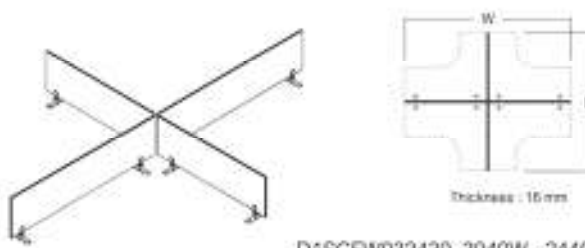

D1SCFW032430	3040W	2440D	300H
D1SCFW032432	3240W	2440D	300H
D1SCFW032436	3640W	2440D	300H
<hr/>			
D1SCFW033032	3240W	3040D	300H
D1SCFW033036	3640W	3040D	300H
<hr/>			
D1SCFW042430	3040W	2440D	400H
D1SCFW042432	3240W	2440D	400H
D1SCFW042436	3640W	2440D	400H
<hr/>			
D1SCFW043032	3240W	3040D	400H
D1SCFW043036	3640W	3040D	400H

Front screen for 90-degree cluster desks (Fabric screen)

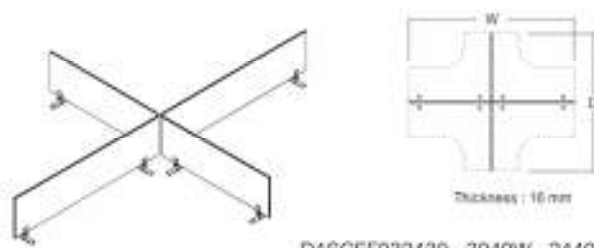

D1SCFF032430	3040W	2440D	300H
D1SCFF032432	3240W	2440D	300H
D1SCFF032436	3640W	2440D	300H
<hr/>			
D1SCFF033032	3240W	3040D	300H
D1SCFF033036	3640W	3040D	300H
<hr/>			
D1SCFF042430	3040W	2440D	400H
D1SCFF042432	3240W	2440D	400H
D1SCFF042436	3640W	2440D	400H
<hr/>			
D1SCFF043032	3240W	3040D	400H
D1SCFF043036	3640W	3040D	400H

FRONT SCREEN FOR 90-DEGREE CLUSTER DESKS

Front screen for 90-degree cluster desks (Glass screen)

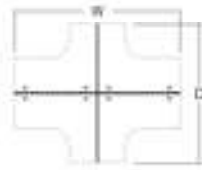
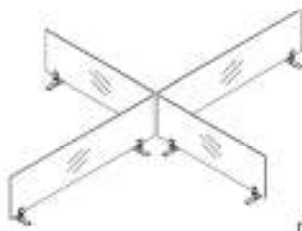

Thickness : 6 mm

D1SCFG032430	3040W	2440D	300H
D1SCFG032432	3240W	2440D	300H
D1SCFG032436	3640W	2440D	300H
D1SCFG033032	3240W	3040D	300H
D1SCFG033036	3640W	3040D	300H
D1SCFG042430	3040W	2440D	400H
D1SCFG042432	3240W	2440D	400H
D1SCFG042436	3640W	2440D	400H
D1SCFG043032	3240W	3040D	400H
D1SCFG043036	3640W	3040D	400H

SCREEN PLUS MODESTY FOR SINGLE DESK

Screen plus modesty for single desk (Wooden screen)

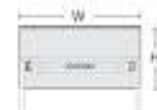
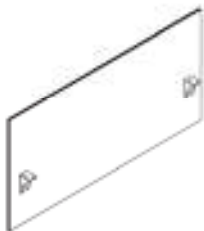

D1SSDW0712	1200W	16D	700H
D1SSDW0714	1400W	16D	700H
D1SSDW0715	1500W	16D	700H
D1SSDW0716	1600W	16D	700H
D1SSDW0718	1800W	16D	700H
D1SSDW0812	1200W	16D	800H
D1SSDW0814	1400W	16D	800H
D1SSDW0815	1500W	16D	800H
D1SSDW0816	1600W	16D	800H
D1SSDW0818	1800W	16D	800H

For End desk :

D1SSDW0701	1240W	16D	700H
D1SSDW0702	1540W	16D	700H
D1SSDW0801	1240W	16D	800H
D1SSDW0802	1540W	16D	800H

Screen plus modesty for single desk (Fabric screen)



D1SSDF0712	1200W	16D	700H
D1SSDF0714	1400W	16D	700H
D1SSDF0715	1500W	16D	700H
D1SSDF0716	1600W	16D	700H
D1SSDF0718	1800W	16D	700H
D1SSDF0812	1200W	16D	800H
D1SSDF0814	1400W	16D	800H
D1SSDF0815	1500W	16D	800H
D1SSDF0816	1600W	16D	800H
D1SSDF0818	1800W	16D	800H

For End desk :

D1SSDF0701	1240W	16D	700H
D1SSDF0702	1540W	16D	700H
D1SSDF0801	1240W	16D	800H
D1SSDF0802	1540W	16D	800H

SCREEN PLUS MODESTY FOR SINGLE DESK

Screen plus modesty for single bench desks (Wooden screen)



D1SSBW0724	2400W	16D	700H
D1SSBW0728	2800W	16D	700H
D1SSBW0730	3000W	16D	700H
D1SSBW0732	3200W	16D	700H
D1SSBW0736	3600W	16D	700H
<hr/>			
D1SSBW0824	2400W	16D	800H
D1SSBW0828	2800W	16D	800H
D1SSBW0830	3000W	16D	800H
D1SSBW0832	3200W	16D	800H
D1SSBW0836	3600W	16D	800H

Screen plus modesty for single bench desks (Fabric screen)



D1SSBF0724	2400W	16D	700H
D1SSBF0728	2800W	16D	700H
D1SSBF0730	3000W	16D	700H
D1SSBF0732	3200W	16D	700H
D1SSBF0736	3600W	16D	700H
<hr/>			
D1SSBF0824	2400W	16D	800H
D1SSBF0828	2800W	16D	800H
D1SSBF0830	3000W	16D	800H
D1SSBF0832	3200W	16D	800H
D1SSBF0836	3600W	16D	800H

Screen plus modesty for single connector desk (Wooden screen)



D1SSCW0712	1200W	16D	700H
D1SSCW0714	1400W	16D	700H
D1SSCW0715	1500W	16D	700H
D1SSCW0716	1600W	16D	700H
D1SSCW0718	1800W	16D	700H
<hr/>			
D1SSCW0812	1200W	16D	800H
D1SSCW0814	1400W	16D	800H
D1SSCW0815	1500W	16D	800H
D1SSCW0816	1600W	16D	800H
D1SSCW0818	1800W	16D	800H

Screen plus modesty for single connector desk (Fabric screen)



D1SSCF0712	1200W	16D	700H
D1SSCF0714	1400W	16D	700H
D1SSCF0715	1500W	16D	700H
D1SSCF0716	1600W	16D	700H
D1SSCF0718	1800W	16D	700H
<hr/>			
D1SSCF0812	1200W	16D	800H
D1SSCF0814	1400W	16D	800H
D1SSCF0815	1500W	16D	800H
D1SSCF0816	1600W	16D	800H
D1SSCF0818	1800W	16D	800H

SCREEN PLUS MODESTY FOR DOUBLE DESKS

Screen plus modesty for double desks (Wooden screen)



D1SDDW0712	1200W	16D	700H
D1SDDW0714	1400W	16D	700H
D1SDDW0715	1500W	16D	700H
D1SDDW0716	1600W	16D	700H
D1SDDW0718	1800W	16D	700H
<hr/>			
D1SDDW0812	1200W	16D	800H
D1SDDW0814	1400W	16D	800H
D1SDDW0815	1500W	16D	800H
D1SDDW0816	1600W	16D	800H
D1SDDW0818	1800W	16D	800H

Screen plus modesty for double desks (Fabric screen)



D1SDDF0712	1200W	16D	700H
D1SDDF0714	1400W	16D	700H
D1SDDF0715	1500W	16D	700H
D1SDDF0716	1600W	16D	700H
D1SDDF0718	1800W	16D	700H
<hr/>			
D1SDDF0812	1200W	16D	800H
D1SDDF0814	1400W	16D	800H
D1SDDF0815	1500W	16D	800H
D1SDDF0816	1600W	16D	800H
D1SDDF0818	1800W	16D	800H

SCREEN PLUS MODESTY FOR DOUBLE DESKS

Screen plus modesty for double bench desks (Wooden screen)

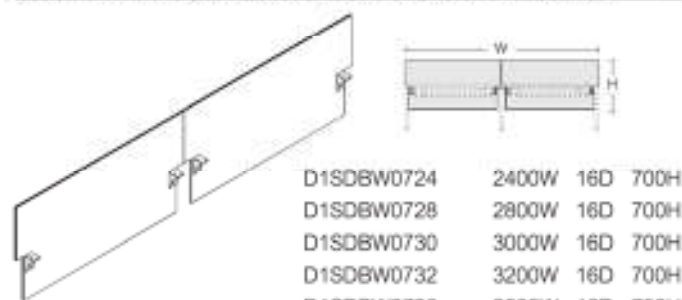

D1SDBW0724	2400W	16D	700H
D1SDBW0728	2800W	16D	700H
D1SDBW0730	3000W	16D	700H
D1SDBW0732	3200W	16D	700H
D1SDBW0736	3600W	16D	700H

D1SDBW0824	2400W	16D	800H
D1SDBW0828	2800W	16D	800H
D1SDBW0830	3000W	16D	800H
D1SDBW0832	3200W	16D	800H
D1SDBW0836	3600W	16D	800H

Screen plus modesty for double bench desks (Fabric screen)

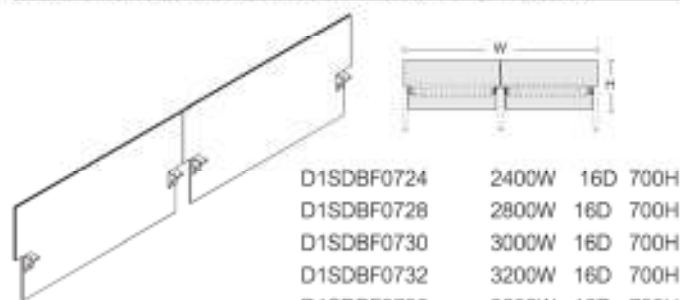

D1SDBF0724	2400W	16D	700H
D1SDBF0728	2800W	16D	700H
D1SDBF0730	3000W	16D	700H
D1SDBF0732	3200W	16D	700H
D1SDBF0736	3600W	16D	700H

D1SDBF0824	2400W	16D	800H
D1SDBF0828	2800W	16D	800H
D1SDBF0830	3000W	16D	800H
D1SDBF0832	3200W	16D	800H
D1SDBF0836	3600W	16D	800H

60 Screen plus modesty for double connector desks (Wooden screen)

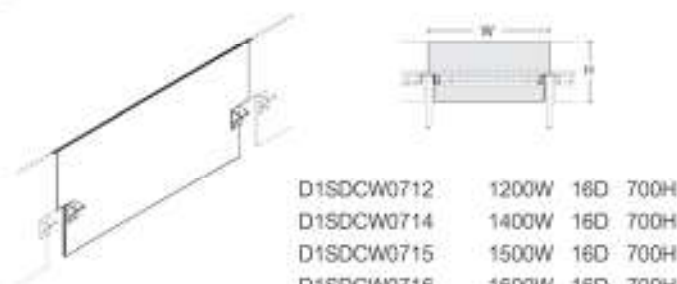

D1SDCW0712	1200W	16D	700H
D1SDCW0714	1400W	16D	700H
D1SDCW0715	1500W	16D	700H
D1SDCW0716	1600W	16D	700H
D1SDCW0718	1800W	16D	700H

D1SDCW0812	1200W	16D	800H
D1SDCW0814	1400W	16D	800H
D1SDCW0815	1500W	16D	800H
D1SDCW0816	1600W	16D	800H
D1SDCW0818	1800W	16D	800H

Screen plus modesty for double connector desks (Fabric screen)

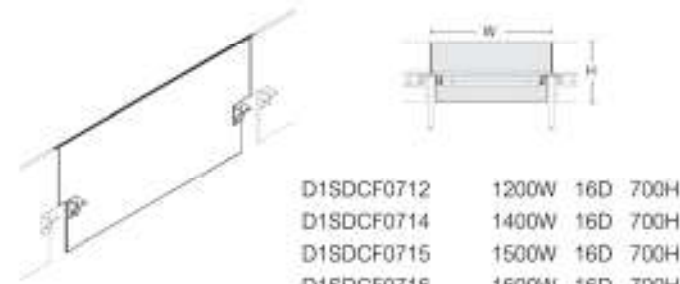

D1SDCF0712	1200W	16D	700H
D1SDCF0714	1400W	16D	700H
D1SDCF0715	1500W	16D	700H
D1SDCF0716	1600W	16D	700H
D1SDCF0718	1800W	16D	700H

D1SDCF0812	1200W	16D	800H
D1SDCF0814	1400W	16D	800H
D1SDCF0815	1500W	16D	800H
D1SDCF0816	1600W	16D	800H
D1SDCF0818	1800W	16D	800H

SCREEN PLUS MODESTY FOR 120-DEGREE CLUSTER DESKS

Screen plus modesty for 120-degree cluster desks (Wooden screen)



D1SCTW0710	2370DIA.	1000L	700H
D1SCTW0711	2540DIA.	1100L	700H
D1SCTW0712	2720DIA.	1200L	700H

D1SCTW0810	2370DIA.	1000L	800H
D1SCTW0811	2540DIA.	1100L	800H
D1SCTW0812	2720DIA.	1200L	800H

Screen plus modesty for 120-degree cluster desks (Fabric screen)

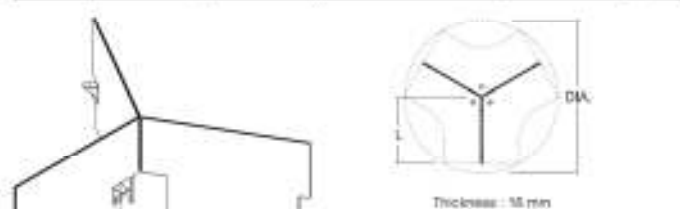

D1SCTF0710	2370DIA.	1000L	700H
D1SCTF0711	2540DIA.	1100L	700H
D1SCTF0712	2720DIA.	1200L	700H

D1SCTF0810	2370DIA.	1000L	800H
D1SCTF0811	2540DIA.	1100L	800H
D1SCTF0812	2720DIA.	1200L	800H

SCREEN PLUS MODESTY FOR 90-DEGREE CLUSTER DESKS

Screen plus modesty for 90-degree cluster desks (Wooden screen)

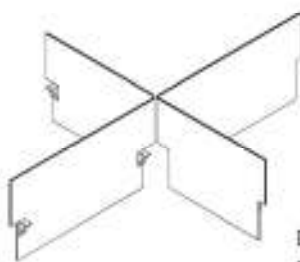

Thickness : 16 mm

D1SCFW072430	3040W	2440D	700H
D1SCFW072432	3240W	2440D	700H
D1SCFW072436	3640W	2440D	700H
<hr/>			
D1SCFW073032	3240W	3040D	700H
D1SCFW073036	3640W	3040D	700H
<hr/>			
D1SCFW082430	3040W	2440D	800H
D1SCFW082432	3240W	2440D	800H
D1SCFW082436	3640W	2440D	800H
<hr/>			
D1SCFW083032	3240W	3040D	800H
D1SCFW083036	3640W	3040D	800H

Screen plus modesty for 90-degree cluster desks (Fabric screen)

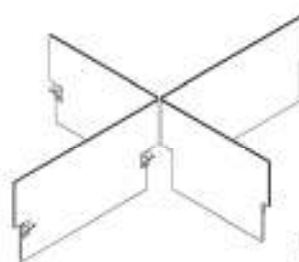

Thickness : 16 mm

D1SCFF072430	3040W	2440D	700H
D1SCFF072432	3240W	2440D	700H
D1SCFF072436	3640W	2440D	700H
<hr/>			
D1SCFF073032	3240W	3040D	700H
D1SCFF073036	3640W	3040D	700H
<hr/>			
D1SCFF082430	3040W	2440D	800H
D1SCFF082432	3240W	2440D	800H
D1SCFF082436	3640W	2440D	800H
<hr/>			
D1SCFF083032	3240W	3040D	800H
D1SCFF083036	3640W	3040D	800H

END SCREEN

End screen for single desk (Wooden screen)



D1SSEW07600	600W	16D	700H
D1SSEW07750	750W	16D	700H
<hr/>			
D1SSEW08600	600W	16D	800H
D1SSEW08750	750W	16D	800H

End screen for single desk (Fabric screen)



D1SSEF07600	600W	16D	700H
D1SSEF07750	750W	16D	700H
<hr/>			
D1SSEF08600	600W	16D	800H
D1SSEF08750	750W	16D	800H

End screen for double desks (Wooden screen)



D1SDEW07120	1200W	16D	700H
D1SDEW07124	1240W	16D	700H
D1SDEW07150	1500W	16D	700H
D1SDEW07154	1540W	16D	700H
<hr/>			
D1SDEW08120	1200W	16D	800H
D1SDEW08124	1240W	16D	800H
D1SDEW08150	1500W	16D	800H
D1SDEW08154	1540W	16D	800H

End screen for double desks (Fabric screen)

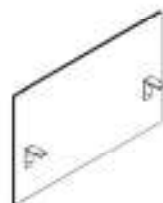

D1SDEF07120	1200W	16D	700H
D1SDEF07124	1240W	16D	700H
D1SDEF07150	1500W	16D	700H
D1SDEF07154	1540W	16D	700H
<hr/>			
D1SDEF08120	1200W	16D	800H
D1SDEF08124	1240W	16D	800H
D1SDEF08150	1500W	16D	800H
D1SDEF08154	1540W	16D	800H

SIDE SCREEN

Side screen



(16 mm thick board)

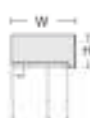

D1SSSW0306	700W	16D	300H
D1SSSW0307	850W	16D	300H
<hr/>			
D1SSSW0406	700W	16D	400H
D1SSSW0407	850W	16D	400H

Side screen (Fabric screen)



(16 mm thick board)



D1SSSF0306	700W	16D	300H
D1SSSF0307	850W	16D	300H
<hr/>			
D1SSSF0406	700W	16D	400H
D1SSSF0407	850W	16D	400H

DOUBLE TOP GAP COVER

Double top gap cover

62

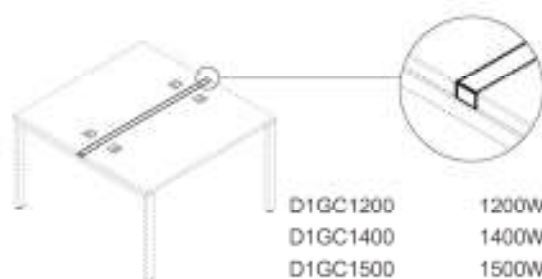

D1GC1200	1200W	100D	26H
D1GC1400	1400W	100D	26H
D1GC1500	1500W	100D	26H
D1GC1600	1600W	100D	26H
D1GC1800	1800W	100D	26H

MODESTY PANEL FOR SINGLE DESK

Wooden modesty panel for single desk

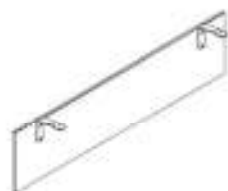

D1MPSW1000	800W	16D	350H
D1MPSW1100	900W	16D	350H
D1MPSW1200	1000W	16D	350H
D1MPSW1400	1200W	16D	350H
D1MPSW1500	1300W	16D	350H
D1MPSW1600	1400W	16D	350H
D1MPSW1800	1600W	16D	350H

For End desk :

D1MPSW1240	1040W	16D	350H
D1MPSW1540	1340W	16D	350H

Fabric modesty panel for single desk

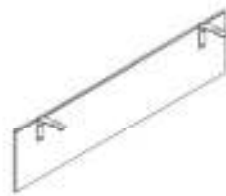

D1MPSF1000	800W	16D	350H
D1MPSF1100	900W	16D	350H
D1MPSF1200	1000W	16D	350H
D1MPSF1400	1200W	16D	350H
D1MPSF1500	1300W	16D	350H
D1MPSF1600	1400W	16D	350H
D1MPSF1800	1600W	16D	350H

For End desk :

D1MPSW1240	1040W	16D	350H
D1MPSW1540	1340W	16D	350H

Steel modesty panel for single desk Type:A

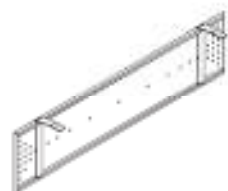

D1MPSS1000A	800W	0.7D	350H
D1MPSS1100A	900W	0.7D	350H
D1MPSS1200A	1000W	0.7D	350H
D1MPSS1400A	1200W	0.7D	350H
D1MPSS1500A	1300W	0.7D	350H
D1MPSS1600A	1400W	0.7D	350H
D1MPSS1800A	1600W	0.7D	350H

For End desk :

D1MPSS1240A	1040W	0.7D	350H
D1MPSS1540A	1340W	0.7D	350H

Steel modesty panel for single desk Type:B



D1MPSS1000B	800W	0.7D	350H
D1MPSS1100B	900W	0.7D	350H
D1MPSS1200B	1000W	0.7D	350H
D1MPSS1400B	1200W	0.7D	350H
D1MPSS1500B	1300W	0.7D	350H
D1MPSS1600B	1400W	0.7D	350H
D1MPSS1800B	1600W	0.7D	350H

For End desk :

D1MPSS1240B	1040W	0.7D	350H
D1MPSS1540B	1340W	0.7D	350H

MODESTY PANEL FOR EXECUTIVE DESK

Wooden modesty panel for executive desk



D1MPEW1800 1600W 16D 350H
D1MPEW2000 1800W 16D 350H

Fabric modesty panel for executive desk



D1MPEF1800 1600W 16D 350H
D1MPEF2000 1800W 16D 350H

Steel modesty panel for executive desk Type:A

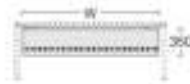

D1MPES1800A 1600W 0.7D 350H
D1MPES2000A 1800W 0.7D 350H

Steel modesty panel for executive desk Type:B

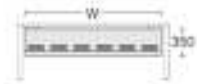

D1MPES1800B 1600W 0.7D 350H
D1MPES2000B 1800W 0.7D 350H

WORKTOOLS

ACCESSORIES FOR HANGING ON SCREEN

Pencil cup



D1APJ001 80W 76D 123H

Pencil tray



D1APT001 220W 95D 60H

Accessories tray 150



D1AAT001 150W 165D 150H

Accessories tray 300



D1AAT002 300W 165D 150H

Horizontal filing tray



D1AHT001 320W 35D 240H

Vertical filing tray



D1AVT001 80W 237D 312H

Magnetic board 300



D1AMB300 300W 8D 300H

Magnetic board 600



D1AMB600 600W 8D 300H

BINDER SHELF FOR DOUBLE DESKS

Binder shelf 300

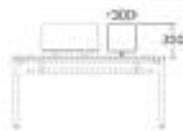

D1AMS0303 300W 300D 380H

(USE WITH DOUBLE TOP ONLY)

Binder shelf 600



D1ABS0360 600W 300D 380H

(USE WITH DOUBLE TOP ONLY)

CPU HOLDER AND STAND

Adjustable CPU holder



D1CPU001 245W 207D 530H

CPU holder



D1CPU002 212W 440D 485H

64 Mobile CPU stand



D1CPU003 225W 500D 305H

KEYBOARD TRAY

Keyboard tray type : A



TRAY DIMENSION
AKT001 650W 250D 19H

- Steel sliding track
- Vacuum forming tray

Keyboard tray type : B



TRAY DIMENSION
AKT002 650W 250D 19H

- Steel sliding track
- Vacuum forming tray

Keyboard tray type : C



TRAY DIMENSION
AKT003 650W 320D 19H

- Ball bearing sliding rails
- Vacuum forming tray

Keyboard tray type : D



TRAY DIMENSION
AKT004 650W 320D 19H

- Ball bearing sliding rails
- Wooden tray

Keyboard tray type : E

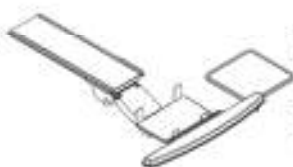

TRAY DIMENSION
AKT005 720W 250D 30H

- Steel sliding track
- Steel tray

Keyboard tray type : F



TRAY DIMENSION
AKT006 635W 260D 30H

- Ball bearing sliding rails
- Plastic tray

ELECTRICAL AND DATA

CABLE MANAGEMENT

Cable riser for single desk leg : A



D1ESA001 80W 60D 680H

Cable riser for single desk leg : B



D1ESB001 80W 60D 635H

Cable riser for double desks leg : A



D1EDA001 150W 68D 683H

Cable riser for double desks leg : B



D1EDB001 150W 68D 640H

Power pole



EPP240	75W 75D 2400H
EPP250	75W 75D 2500H
EPP260	75W 75D 2600H
EPP270	75W 75D 2700H
EPP280	75W 75D 2800H
EPP290	75W 75D 2900H
EPP300	75W 75D 3000H

CABINET

PEDESTALS AND CABINETS

Desk height pedestal

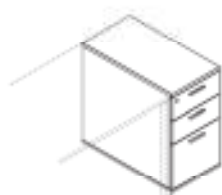

D1POS0604 400W 600D 750H
D1POS0704 400W 750D 750H



Desk height pedestal with bookshelf



D1PBS0604L 400W 600D 1150H
D1PBS0604R 400W 600D 1150H
D1PBS0704L 400W 750D 1150H
D1PBS0704R 400W 750D 1150H



Sliding door cabinet



D1CSS0412 1240W 400D 750H
D1CSS0415 1540W 400D 750H



Sliding door cabinet with bookshelf



D1CBS0412 1240W 400D 1150H
D1CBS0415 1540W 400D 1150H



MOBILE PEDESTALS

2-drawer mobile pedestal



D1PDM0405 400W 500D 540H

2-drawer mobile pedestal with seat cushion



D1PDMC0406 400W 500D 600H

3-drawer mobile pedestal



D1PDM0406 400W 500D 645H

3-drawer mobile pedestal with seat cushion



D1PDMC0407 400W 500D 705H

66

Open shelf with 2-drawer mobile cabinet



D1PCM0805 800W 500D 540H

Open shelf with 2-drawer mobile cabinet and seat cushion



D1PCMC0806 800W 500D 600H

MULTI TASK TABLE

DINING TABLE

Square multi-task table

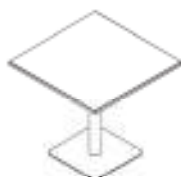

D1MS800 800W 800D 750H



Circular multi-task table



D1MC800 800DIA. 750H



DESKS OPTION

	Material	Paint	Melamine	Laminate	Glass	Fabric
	Steel	White - C44	White - M01	White - H01	Frosted White - G01	All colors
	Wood	Silver Grey - A35	Light Grey - M02	Light Grey - H02	White - G02	
	Glass	Dark Grey - A38	Dark Grey - M03	Black - H03	Black - G03	
	Fabric	Black - A07	Black - M04	Blond Alamoza - H11	Clear Glass - G04	
		Platinum - G50	Shimo Ash - M11	Hazelnut cherry - H12		
			Cherry Capuchino - M12	Vintage Teak - H13		
			Wenge - M13			
			Grey Tourmaline - M14			

Product Option	Steel	Wood	Glass	Fabric	White - C44	Silver Grey - A35	Dark Grey - A38	Black - A07	Platinum - G50	White - M01	Light Grey - M02	Dark Grey - M03	Black - M04	Shimo Ash - M11	Cherry Capuchino - M12	Wenge - M13	Grey Tourmaline - M14	White - H01	Light Grey - H02	Black - H03	Blond Alamoza - H11	Hazelnut cherry - H12	Vintage Teak - H13	Frosted White - G01	White - G02	Black - G03	Clear Glass - G04	All colors		
Single desk																														
- Rectangle single desk																														
Top		■								■	■	■	■	■	■	■	■	■	■	■	■	■	■	■						
Leg	■				■	■	■	■	■																					
- L-shaped single desk																														
Top		■								■	■	■	■	■	■	■	■	■	■	■	■	■	■	■						
Leg	■				■	■	■	■	■																					
- End desk																														
Top		■								■	■	■	■	■	■	■	■	■	■	■	■	■	■	■						
Leg	■				■	■	■	■	■																					
Single bench desks																														
- Rectangle single bench desks																														
Top		■								■	■	■	■	■	■	■	■	■	■	■	■	■	■	■						
Leg	■				■	■	■	■	■																					
- L-shaped single bench desks																														
Top		■								■	■	■	■	■	■	■	■	■	■	■	■	■	■	■						
Leg	■				■	■	■	■	■																					
Single connector desk																														
- Rectangle single connector desk																														
Top		■								■	■	■	■	■	■	■	■	■	■	■	■	■	■	■						
Leg	■				■	■	■	■	■																					
Double desks																														
- Rectangle double desks																														
Top		■								■	■	■	■	■	■	■	■	■	■	■	■	■	■	■						
Leg	■				■	■	■	■	■																					
- L-shaped double desks																														
Top		■								■	■	■	■	■	■	■	■	■	■	■	■	■	■	■						
Leg	■				■	■	■	■	■																					
Double bench desks																														
- Rectangle double bench desks																														
Top		■								■	■	■	■	■	■	■	■	■	■	■	■	■	■	■						
Leg	■				■	■	■	■	■																					
Double connector desks																														
- Rectangle double connector desks																														
Top		■								■	■	■	■	■	■	■	■	■	■	■	■	■	■	■						
Leg	■				■	■	■	■	■																					
120-degree cluster desks																														
- 120-degree cluster desks																														
Top		■								■	■	■	■	■	■	■	■	■	■	■	■	■	■	■						
Leg	■				■	■	■	■	■																					

DESKS OPTION

	Material				Paint				Melamine				Laminate				Glass			Fabric								
	Steel	Wood	Glass	Fabric	White - C14	Silver Grey - A35	Dark Grey - A38	Black - A07	Platinum - G50	White - M01	Light Grey - M02	Dark Grey - M03	Black - M04	Shimo Ash - M11	Cherry Capucino - M12	Wenge - M13	Grey Tourmaline - M14	White - H01	Light Grey - H02	Black - H03	Blond Alamosa - H11	Hazelnut cherry - H12	Vintage Teak - H13	Frosted White - G01	White - G02	Black - G03	Clear Glass - G04	All colors
Support pedestal and support cabinet																												
- 2-drawer support pedestal																												
- 3-drawer support pedestal																												
- Open shelf with 2-drawer support cabinet																												
- CPU with sliding door support cabinet																												
Top		■							■	■	■	■	■	■	■	■	■	■	■	■	■	■	■	■	■	■	■	■
Front		■							■	■	■	■	■	■	■	■	■	■	■	■	■	■	■	■	■	■	■	■
Body		■							■	■	■	■																
Return desk																												
- Single return desk																												
- Double return desk																												
Top		■							■	■	■	■	■	■	■	■	■	■	■	■	■	■	■	■	■	■	■	■
Leg	■				■	■	■	■	■																			
- Return desk with support pedestal																												
Top		■							■	■	■	■	■	■	■	■	■	■	■	■	■	■	■	■	■	■	■	■
Front		■							■	■	■	■	■	■	■	■	■	■	■	■	■	■	■	■	■	■	■	■
Body		■							■	■	■	■																
Extension top																												
- Side top extension																												
- Lower top extension																												
Top		■							■	■	■	■	■	■	■	■	■	■	■	■	■	■	■	■	■	■	■	■
Bracket	■				■	■	■	■	■																			
Executive group																												
- Wooden top executive desk with top access																												
Top		■							■	■	■	■	■	■	■	■	■	■	■	■	■	■	■	■	■	■	■	■
Leg	■				■	■	■	■	■																			
- Glass top executive desk																												
- Glass top return desk																												
Top			■																					■	■			
Leg	■				■	■	■	■	■																			
- Wooden top executive desk with support cabinet																												
Top		■							■	■	■	■	■	■	■	■	■	■	■	■	■	■	■	■	■	■	■	■
Leg	■				■	■	■	■	■																			
- Glass top executive desk with support cabinet																												
Top			■																					■	■			
Leg	■				■	■	■	■	■																			
- Executive support cabinet																												
Top		■							■	■	■	■	■	■	■	■	■	■	■	■	■	■	■	■	■	■	■	■
Front		■							■	■	■	■	■	■	■	■	■	■	■	■	■	■	■	■	■	■	■	■
Body		■							■	■	■	■																

DESKS OPTION

Material	Paint	Melamine	Laminate	Glass	Fabric
Steel	White - C44	White - M01	White - H01	White - G01	All colors
Wood	Silver Grey - A36	Light Grey - M02	Light Grey - H02	White - G02	
Glass	Dark Grey - A38	Dark Grey - M03	Black - H03	Black - G03	
Fabric	Black - A07	Black - M04	Blond Altonozia - H11	Clear Glass - G04	
	Platinum - C50	Shimo Ash - M11	Hazelnut cherry - H12		
		Cherry Capuchino - M12	Vintage Teak - H13		
		Nenge - M13	Frosted White - G01		
		Grey Tourmaline - M14			

70

Meeting and conference table					
Wooden top square meeting table					
Top	■				
Leg	■	■	■	■	■
Glass top square meeting table					
Top		■			
Leg	■	■	■	■	■
Wooden top rectangle meeting table					
Top	■				
Leg	■	■	■	■	■
Glass top rectangle meeting table					
Top		■			
Leg	■	■	■	■	■
- Wooden top conference tables					
Top	■				
Leg	■	■	■	■	■
- Glass top conference tables					
Top		■			
Leg	■	■	■	■	■
- Wooden top conference connector table					
Top	■				
Leg	■	■	■	■	■
- Glass top conference connector table					
Top		■			
Leg	■	■	■	■	■
Training desks					
- Training single desk					
- Training bench desks					
- Training connector desk					
Top	■				
Leg	■	■	■	■	■
Reception counter					
- Single reception counter					
- Straight reception counter					
- Corner reception counter					
- Connector reception counter					
- Straight reception counters with cabinet					
Glass top		■			
Panel	■				
Desk Top	■				
Leg	■	■	■	■	■

SCREEN OPTION

Material		Paint				Melamine						Laminate				Glass			Fabric						
Steel	Wood	White -C44	Silver Grey - A35	Dark Grey - A38	Black - A07	Platinum - G50	White - M01	Light Grey - M02	Dark Grey - M03	Black - M04	Shimo Ash - M11	Cherry Capuchino - M12	Wenge - M13	Grey Tourmaline - M14	White - H01	Light Grey - H02	Black - H03	Blond Alamos8 - H11	Hazelnut cherry - H12	Vintage Teak - H13	Frosted White - G01	White -G02	Black - G03	Clear Glass - G04	All colors

Screen Type	Material	Paint	Melamine	Laminate	Glass	Fabric
Front screen for single desk						
- Front screen for single desk						
- Wooden screen						
Panel	■					
Bracket	■	■	■	■	■	■
- Fabric screen						
Panel		■				■
Bracket	■	■	■	■	■	■
- Glass screen						
Panel		■			■	■
Bracket	■	■	■	■	■	■
- Front screen for single bench desks						
- Front screen for single connector desk						
- Wooden screen						
Panel	■					
Bracket	■	■	■	■	■	■
- Fabric screen						
Panel		■				■
Bracket	■	■	■	■	■	■
Front screen for double desks						
- Front screen for double desks						
- Wooden screen						
Panel	■					
Bracket	■	■	■	■	■	■
- Fabric screen						
Panel		■				■
Bracket	■	■	■	■	■	■
- Glass screen						
Panel		■			■	■
Bracket	■	■	■	■	■	■
- Front screen for double bench desks						
- Front screen for double connector desks						
- Wooden screen						
Panel	■					
Bracket	■	■	■	■	■	■
- Fabric screen						
Panel		■				■
Bracket	■	■	■	■	■	■

SCREEN OPTION

	Material				Paint				Melamine				Laminate				Glass		Fabric											
	Steel	Wood	Glass	Fabric	White - C44	Silver Grey - A35	Dark Grey - A38	Black - A07	Platinum - G50	White - M01	Light Grey - M02	Dark Grey - M03	Black - M04	Shimo Ash - M11	Cherry Capuchino - M12	Wenge - M13	Grey Tourmaline - M14	White - H01	Light Grey - H02	Black - H03	Blond Alamosa - H11	Hazelnut cherry - H12	Vintage Teak - H13	Frosted White - G01	White - G02	Black - G03	Clear Glass - G04	All colors		
Screen plus modesty for 120-degree cluster desks																														
- Screen plus modesty for 120-degree cluster desks																														
- Wooden screen																														
	Panel	■								■	■	■	■	■	■	■	■	■	■	■	■	■	■	■	■	■	■	■		
	Bracket	■			■	■	■	■	■																					
- Fabric screen																														
	Panel		■																									■		
	Bracket	■			■	■	■	■	■																					
Screen plus modesty for 90-degree cluster desks																														
- Screen plus modesty for 90-degree cluster desks																														
- Wooden screen																														
	Panel	■								■	■	■	■	■	■	■	■	■	■	■	■	■	■	■	■	■	■	■	■	
	Bracket	■			■	■	■	■	■																					
- Fabric screen																														
	Panel		■																									■		
	Bracket	■			■	■	■	■	■																					
End screen																														
- End screen for single desk																														
- End screen for double desks																														
- Wooden screen																														
	Panel	■								■	■	■	■	■	■	■	■	■	■	■	■	■	■	■	■	■	■	■	■	
	Bracket	■			■	■	■	■	■																					
- Fabric screen																														
	Panel		■																									■		
	Bracket	■			■	■	■	■	■																					
Side screen																														
- Side screen																														
- Wooden screen																														
	Panel	■								■	■	■	■	■	■	■	■	■	■	■	■	■	■	■	■	■	■	■	■	
	Bracket	■			■	■	■	■	■																					
- Fabric screen																														
	Panel		■																									■		
	Bracket	■			■	■	■	■	■																					
Double top gap cover																														
- Double top gap cover																														
	Body	■			■	■	■	■	■																					

SCREEN OPTION

Material	Paint	Melamine	Laminate	Glass	Fabric
Steel	White - C44	White - M01	White - H01	White - G01	All colors
Wood	Silver Grey - A35	Light Grey - M02	Light Grey - H02	White - G02	
Glass	Dark Grey - A38	Dark Grey - M03	Black - H03	Black - G03	
Fabric	Black - A07	Black - M04	Blond Alamosa - H11	Clear Glass - G04	
	Platinum - C50	Shimo Ash - M11	Hazelnut cherry - H12		
		Cherry Capuchino - M12	Vintage Teak - H13		
		Wenge - M13	Frosted White - G01		
		Grey Tourmaline - M14			

74

Modesty panel for single desk	Steel	Wood	Glass	Fabric	White - C44	Silver Grey - A35	Dark Grey - A38	Black - A07	Platinum - C50	White - M01	Light Grey - M02	Dark Grey - M03	Black - M04	Shimo Ash - M11	Cherry Capuchino - M12	Wenge - M13	Grey Tourmaline - M14	White - H01	Light Grey - H02	Black - H03	Blond Alamosa - H11	Hazelnut cherry - H12	Vintage Teak - H13	Frosted White - G01	White - G02	Black - G03	Clear Glass - G04	Fabric	
- Wooden modesty panel for single desk																													
Panel		■																											
Bracket	■					■	■	■	■	■																			
- Steel modesty panel for single desk																													
Panel	■					■	■	■	■	■																			
Bracket	■					■	■	■	■	■																			
- Fabric modesty panel for single desk																													■
Panel																													■
Bracket	■					■	■	■	■	■																			
Modesty panel for executive desk																													
- Wooden modesty panel for executive desk																													
Panel		■																											
Bracket	■					■	■	■	■	■																			
- Steel modesty panel for executive desk																													
Panel	■					■	■	■	■	■																			
Bracket	■					■	■	■	■	■																			
- Fabric modesty panel for executive desk																													■
Panel																													■
Bracket	■					■	■	■	■	■																			

WORKTOOLS OPTION

Accessories for hanging on screen	Steel	Wood	Glass	Fabric	White - C44	Silver Grey - A35	Dark Grey - A38	Black - A07	Platinum - C50	White - M01	Light Grey - M02	Dark Grey - M03	Black - M04	Shimo Ash - M11	Cherry Capuchino - M12	Wenge - M13	Grey Tourmaline - M14	White - H01	Light Grey - H02	Black - H03	Blond Alamosa - H11	Hazelnut cherry - H12	Vintage Teak - H13	Frosted White - G01	White - G02	Black - G03	Clear Glass - G04	Fabric	
- Pencil cup																													
- Pencil tray																													
- Accessories tray 150																													
- Accessories tray 300																													
- Horizontal filing tray																													
- Vertical filing tray																													
- Magnetic board 300																													
- Magnetic board 600																													
Body	■					■	■	■	■	■																			
Binder shelf for double logs																													
- Binder shelf 300																													
- Binder shelf 600																													
Body	■					■	■	■	■	■																			
CPU holder and stand																													
- Adjustable CPU holder																													
- CPU holder																													
- Mobile CPU stand																													
Body	■					■	■	■	■	■																			

WORKTOOLS OPTION

	Material				Paint				Melamine						Laminate				Glass		Fabric							
	Steel	Wood	Glass	Fabric	White - C14	Silver Grey - A35	Dark Grey - A38	Black - A07	Platinum - C350	White - M01	Light Grey - M02	Dark Grey - M03	Black - M04	Shimo Ash - M11	Cherry Capuchine - M12	Nenge - M13	Grey Tourmaline - M14	White - H01	Light Grey - H02	Black - H03	Blond Alamosia - H11	Hazelnut cherry - H12	Vintage Teak - H13	Frosted White - G01	White - G02	Black - G03	Clear Glass - G04	All colors
Keyboard tray																												
- Keyboard tray type : A																												
- Keyboard tray type : B																												
- Keyboard tray type : C																												
Body	■	■						■																				
- Keyboard tray type : D																												
Body		■								■	■	■	■	■	■	■	■	■	■	■	■	■	■					
- Keyboard tray type : E																												
- Keyboard tray type : F																												
Body	■	■						■																				

75

ELECTRICAL AND DATA OPTION

Cable management																												
- Cable riser for single desk leg : A																												
- Cable riser for single desk leg : B																												
- Cable riser for double desks leg : A																												
- Cable riser for double desks leg : B																												
Body	■							■	■	■	■	■	■															
- Power pole																												
Body	■							■	■	■	■	■	■															

CABINET OPTION

Pedestals and cabinets																												
- Desk height pedestal																												
- Desk height pedestal with bookshelf																												
- Sliding door cabinet																												
- Sliding door cabinet with bookshelf																												
Top, Bookshelf	■									■	■	■	■	■	■	■	■	■	■	■	■	■	■	■	■	■	■	■
Front	■									■	■	■	■	■	■	■	■	■	■	■	■	■	■	■	■	■	■	■
Body	■									■	■	■	■															
Mobile pedestals																												
- 2-drawer mobile pedestal																												
- 3-drawer mobile pedestal																												
- Open shelf with 2-drawer mobile cabinet																												
Top	■									■	■	■	■	■	■	■	■	■	■	■	■	■	■	■	■	■	■	■
Front	■									■	■	■	■	■	■	■	■	■	■	■	■	■	■	■	■	■	■	■
Body	■									■	■	■	■	■	■	■	■	■	■	■	■	■	■	■	■	■	■	■

CABINET OPTION

Material	Paint	Melamine	Laminate	Glass	Fabric
Steel	White - C44	White - M01	White - H01	White - G01	All colors
Wood	Silver Grey - A35	Light Grey - M02	Light Grey - H02	White - G02	
Glass	Dark Grey - A38	Dark Grey - M03	Black - H03	Black - G03	
Fabric	Black - A07	Black - M04	Blond Alamosa - H11	Clear Glass - G04	
	Platinum - G50	Shimo Ash - M11	Hazelnut cherry - H12		
		Cherry Capuchino - M12	Vintage Teak - H13		
		Wenge - M13	Frosted White - G01		
		Grey Tourmaline - M14			

Mobile pedestals	Steel	Wood	Glass	Fabric	White - C44	Silver Grey - A35	Dark Grey - A38	Black - A07	Platinum - G50	White - M01	Light Grey - M02	Dark Grey - M03	Black - M04	Shimo Ash - M11	Cherry Capuchino - M12	Wenge - M13	Grey Tourmaline - M14	White - H01	Light Grey - H02	Black - H03	Blond Alamosa - H11	Hazelnut cherry - H12	Vintage Teak - H13	Frosted White - G01	White - G02	Black - G03	Clear Glass - G04	All colors		
- 2-drawer mobile pedestal with seat cushion																														
- 3-drawer mobile pedestal with seat cushion																														
- Open shelf with 2-drawer mobile cabinet and seat cushion																														
Cushion																														
Top																														
Front																														
Body																														

76

MULTI TASK TABLE OPTION

Dining table	Steel	Wood	Glass	Fabric	White - C44	Silver Grey - A35	Dark Grey - A38	Black - A07	Platinum - G50	White - M01	Light Grey - M02	Dark Grey - M03	Black - M04	Shimo Ash - M11	Cherry Capuchino - M12	Wenge - M13	Grey Tourmaline - M14	White - H01	Light Grey - H02	Black - H03	Blond Alamosa - H11	Hazelnut cherry - H12	Vintage Teak - H13	Frosted White - G01	White - G02	Black - G03	Clear Glass - G04	All colors		
- Square multi-task table																														
- Circular multi-task table																														
Top																														
Leg																														

Finishes

Paint :



White :
C44



Silver Grey :
A35



Dark Grey :
A38



Black :
A07



Platinum :
G50

Melamine (MFC) :



White :
M01



Light Grey :
M02



Dark Grey :
M03



Black :
M04



Shimo Ash :
M11



Cherry Capuchino :
M12



Wenge :
M13



Grey Tourmaline :
M14

Laminate (HPL) :



White :
H01



Light Grey :
H02



Black :
H03



Blond Afrososa :
H11



Hazelnut Cherry :
H12



Vintage Teak :
H13

Glass for desktop surfaces (12 mm.) :

Tempered Glass



White :
G02



Black :
G03



Clear Glass :
G04



Frosted White :
G01

Glass for screen panel (6 mm.) :

Fabric :



Cloud Cream :
032



Sand :
037



Oatmeal :
030



Platinum :
417



Iron Ore :
808



Cloud Pink :
110



Pink Lady :
429



Mulberry :
153



Jade :
466



Blue Bell :
442



Marina :
461



Blue Ice :
039



Dusk Blue :
807



Riviera :
028



Cobalt :
463



Petachio :
427



Mandarin :
467



Scarlet :
034



Blush :
478



Hot Sun :
416



Burgundy :
443



Mercury :
804



Griffin :
805



Atomic :
464



Flint :
119



Petunia :
118



Black :
112

Contributions within LEED: Interior Design and Construction (ID+C)

Siamsteel products are developed and manufactured under commitment to social responsibility values by incorporating with environmentally sustainable materials and manufacturing processes. Our furniture may assist client building to contribute LEED for Interior Design and Construction in Materials & Resources (MR), and Indoor Environmental Quality (IEQ) Credits.

78

Materials & Resources (MR)	
Topic	Intent
MR 2: Construction Waste Management	To divert construction and demolition debris from disposal in landfills and incineration facilities. Redirect recyclable recovered resources back to the manufacturing process and reusable materials to appropriate sites.
MR 3.2: Resource Reuse Furniture and Furnishings	To reuse building materials and products to reduce demand for virgin materials and reduce waste, thereby reducing impacts associated with the extraction and processing of virgin resources.
MR 4: Recycled Content	To increase demand for building products that incorporate recycled content materials, thereby reducing impacts resulting from extraction and processing of virgin materials.
MR 5: Regional Materials	To increase demand for building materials and products that are extracted and manufactured within the region, thereby supporting the regional economy and reducing the environmental impacts resulting from transportation.
MR 7: Certified Wood	To encourage environmentally responsible forest management.

Indoor Environmental Quality (IEQ)	
Topic	Intent
IEQ 4.5: Low-Emitting Materials—Systems Furniture and Seating	To reduce the quantity of indoor air contaminants that are odorous, irritating and/or harmful to the comfort and well-being of installers and occupants.



Environmental Product Declarations

Material	Weight (Kg)	%
Steel	66.15	60.37
Aluminum Extrusion	0.80	0.73
Aluminum Die Casting	0.70	0.64
ABS	0.77	0.70
Particleboard	40.26	36.75
Fabric	0.89	0.81
Total weight	109.57	100.00

Recycle Content	Weight	%
Post-Consumer Recycle Content	19.55	17.14
Pre-Consumer Recycle Content	42.14	38.46
Recycled Content	61.69	55.60





Single Desk



Single Benching



Cluster



Double Benching



SIAM STEEL
INTERNATIONAL PLC.

ISO 9001 ISO 14001 OHSAS 18001

SIAM STEEL INTERNATIONAL PUBLIC COMPANY LIMITED

Showroom: 51 Moo 2, Poochao Road, Bangyeptrak, Phrapradaeng, Samutprakam 10130, THAILAND

Tel: +66 (0) 2384-3000 | Fax: +66 (0) 2384-2330

www.siamsteel.com | E-mail: ceffter@siamsteel.com